

GasAlert **Quattro**

1, 2, 3, and 4 Gas Detector

User Manual

BW
Technologies
by Honeywell

Limited Warranty and Limitation Liability

BW Technologies LP (BW) warrants the product to be free from defects in material and workmanship under normal use and service for a period of two years, beginning on the date of shipment to the buyer. This warranty extends only to the sale of new and unused products to the original buyer. BW's warranty obligation is limited, at BW's option, to refund of the purchase price, repair or replacement of a defective product that is returned to a BW authorized service center within the warranty period. In no event shall BW's liability hereunder exceed the purchase price actually paid by the buyer for the Product.

This warranty does not include:

- a) fuses, disposable batteries or the routine replacement of parts due to the normal wear and tear of the product arising from use;
- b) any product which in BW's opinion, has been misused, altered, neglected or damaged, by accident or abnormal conditions of operation, handling or use;
- c) any damage or defects attributable to repair of the product by any person other than an authorized dealer, or the installation of unapproved parts on the product; or

The obligations set forth in this warranty are conditional on:

- a) proper storage, installation, calibration, use, maintenance and compliance with the product manual instructions and any other applicable recommendations of BW;
- b) the buyer promptly notifying BW of any defect and, if required, promptly making the product available for correction. No goods shall be returned to BW until receipt by the buyer of shipping instructions from BW; and
- c) the right of BW to require that the buyer provide proof of purchase such as the original invoice, bill of sale or packing slip to establish that the product is within the warranty period.

THE BUYER AGREES THAT THIS WARRANTY IS THE BUYER'S SOLE AND EXCLUSIVE REMEDY AND IS IN LIEU OF ALL OTHER WARRANTIES, EXPRESS OR IMPLIED, INCLUDING BUT NOT LIMITED TO ANY IMPLIED WARRANTY OF MERCHANTABILITY OR FITNESS FOR A PARTICULAR PURPOSE. BW SHALL NOT BE LIABLE FOR ANY SPECIAL, INDIRECT, INCIDENTAL, OR BASED ON CONTRACT, TORT OR RELIANCE OR ANY OTHER THEORY.

Since some countries or states do not allow limitation of the term of an implied warranty, or exclusion or limitation of incidental or consequential damages, the limitations and exclusions of this warranty may not apply to every buyer. If any provision of this warranty is held invalid or unenforceable by a court of competent jurisdiction, such holding will not affect the validity or enforceability of any other provision.

Table of Contents

	Page
Contact BW Technologies by Honeywell	1
Introduction	1
Gases Monitored	2
Safety Information - Read First	2
Sensor Poisons and Contaminants	10
Getting Started	11
Parts of the GasAlertQuattro	12
Screen Elements	13
Activating/Deactivating the Detector	15
Startup Sequence	15
Battery Test	15
Segment Test	15
Product Identification and Firmware Revision	15
Startup Message.....	16
Alarm Setpoints	16
Sensor Self Test	17
Auto Zero Sensors.....	18
Next Calibration Due.....	18
Sensors Due for Calibration	19
Bump Test Due.....	19
Sensors Due for Bump Test	20
Startup Self-test Summary.....	21
Installing Fleet Manager II	22

GasAlertQuattro

User Manual

Title	Page
Using Fleet Manager II to Configure the Detector	22
Device Configuration	23
Serial Number Field	24
Firmware Version	24
Hardware Version	24
Startup Message	25
Lockout on Self-Test Error	25
Safe Mode	25
Confidence/Compliance Beep	25
Latching Alarms	26
Force Calibration	26
Force Bump	27
Cal IR Lock	28
Flip Display	28
Stealth	29
Datalog Interval	29
IntelliFlash Interval	30
Confidence/Compliance Beep Interval	30
Language	30
Sensor Configuration	31
Sensor Disabled	31
Calibration Gas (ppm)	32
Calibration Interval	33
Bump Interval	33
Low Alarm	33
High Alarm	33
TWA Alarm	33

Title	Page
STEL Alarm.....	34
Correction Factor (LEL)	34
STEL Interval	34
TWA Period (hours)	35
TWA Method	35
50% LEL = (%CH4).....	35
Auto Zero on Startup.....	35
LEL by Volume CH4	35
10% LEL (of reading) Over-span	36
20.8 Base Reading	36
Low Alarm Acknowledge.....	36
Alarms	37
Stopping a Gas Alarm	41
Computed Gas Exposures	41
Viewing and Clearing Gas Exposures	42
Gas Alarm Setpoints	44
Sample Gas Alarm Setpoints.....	44
Bump Test.....	45
Bump Test Logging	45
Performing a Bump Test	45
Calibration	48
Guidelines	48
Connecting the Gas Cylinder to the Detector	49
Calibration Procedures	50
Single Gas Calibration	50
Quad Gas Calibration	50
Zero Sensor	52

GasAlertQuattro

User Manual

Title	Page
Apply Calibration Gas	52
Days to Next Calibration	54
Calibrating Using an IR Device	55
IR Link With Fleet Manager II	55
Event Logs	57
Datalogs	57
Bump and Calibration Results	58
Downloading Datalogs and Event Logs	59
Software Requirements	60
Maintenance	60
Battery Charging and Maintenance Cautions	60
Charging the Rechargeable Battery	61
Optimum Battery Operation	63
Rechargeable Battery Capacity	63
Replacing the Battery Pack	63
Battery Pack Retaining Screw	63
Replacing the Alkaline Batteries	64
Replacing the Sensors	67
Replacing the Sensor Filter	69
Troubleshooting	70
Startup Troubleshooting	75
Calibration Troubleshooting	77
Bump Test Troubleshooting	77
Replacement Parts and Accessories	78
Specifications	80
General Datalog Specifications	82

List of Figures

Figure	Title	Page
1.	Parts of the GasAlertQuattro	12
2.	Connecting the IR Link	22
3.	Device Configuration via IR Link	23
4.	Device Configuration via MicroDock II.....	24
5.	Sensor Configuration Tab (CO) via MicroDock II	31
6.	Sensor Configuration Tab (CO) via IR Link.....	31
7.	Sensor Configuration Tab (H ₂ S) via MicroDock II.....	32
8.	Bump Test Installation.....	46
9.	Tightening the Calibration Cap.....	47
10.	Calibration Cap Installation	49
11.	Connecting the Gas Cylinder to the Detector.....	50
12.	Attaching the Calibration Cap.....	52
13.	Enter Password Dialog Box.....	55
14.	Device Selection Popup	55
15.	Calibrate Device Dialog Box.....	56
16.	Connecting the Charger Adapter.....	61
17.	Screwdriver	63
18.	Removing the Battery Pack.....	64
19.	Ejector Bar Unhooked from Release Clasp.....	65
20.	Using the Tab to Pull on the Ejector Bar	65
21.	Pulling up on the Ejector Bar	66
22.	Inserting the Alkaline Batteries	66
23.	Replacing a Sensor or Sensor Filter	68

GasAlertQuattro
User Manual

24.	Replacing the Sensor Filter	69
25.	Inserting the Sensor Filter Correctly	69

List of Tables

Table	Title	Page
1.	Gases Monitored	2
2.	International Symbols	9
3.	Sensor Poisons and Contaminants	10
4.	Parts of the GasAlertQuattro	12
5.	Button	14
6.	Connecting the IR Link	22
7.	Alarms	37
8.	Computed Gas Exposures	41
9.	Gas Alarm Setpoints	44
10.	Sample Factory Alarm Setpoints	44
11.	Bump Test Installation	46
12.	Datalog Frequency	57
13.	Connecting the Charger Adapter	62
14.	Troubleshooting	70
15.	Startup Troubleshooting	75
16.	Calibration Troubleshooting	77
17.	Replacement Parts and Accessories	78

GasAlertQuattro

Introduction

Warning

To ensure personal safety, read [Safety Information - Read First](#) and [Cautions](#) before using the detector.

The GasAlertQuattro gas detector (“the detector”) warns of hazardous gas at levels above user-defined alarm setpoints.

The detector is a personal safety device. It is your responsibility to respond properly to the alarm.

Gases Monitored

The following table lists the gases that are monitored by the detector.

Table 1. Gases Monitored

Gas Detected	Unit of Measure
Hydrogen sulfide (H ₂ S)	parts per million (ppm)
Carbon monoxide (CO)	parts per million (ppm)
Combustible gases (LEL)	a) percent of lower explosive limit (%LEL) b) percent by volume methane 0-5.0% v/v
Oxygen (O ₂)	% volume

CAUTION: FOR SAFETY REASONS, THIS EQUIPMENT MUST BE OPERATED AND SERVICED BY QUALIFIED PERSONNEL ONLY. READ AND UNDERSTAND THIS USER MANUAL COMPLETELY BEFORE OPERATING AND SERVICING.

Safety Information - Read First

Use the detector only as specified in this user manual and the quick reference guide, otherwise the protection provided by the detector may be impaired.

International symbols used on the detector and in this user manual are defined in [Table 2](#).

Read the [⚠ Cautions](#) on the following pages before using the detector.

Warning

This instrument contains a lithium polymer battery. Dispose of lithium cells immediately. Do not disassemble and do not dispose of in fire. Do not mix with the solid waste stream. Spent batteries must be disposed of by a qualified recycler or hazardous materials handler.

⚠ Cautions

- **Warning:** Substitution of components may impair Intrinsic Safety.
- Before using the detector, refer to [Sensor Poisons and Contaminants](#).
- **Caution:** For safety reasons, this equipment must be operated and serviced by qualified personnel only. Read and understand this user manual completely before operating or servicing.
- Do not use the detector if it is damaged. Inspect the detector before using. Look for cracks and/or missing parts.
- If the detector is damaged or parts are missing, contact [BW Technologies by Honeywell](#) immediately.
- Only use sensor(s) that are specifically designed for the GasAlertQuattro. Refer to [Replacement Parts and Accessories](#).
- Calibrate the detector before first-time use and then on a regular schedule, depending on use and sensor exposure to poisons and contaminants. BW Technologies by Honeywell recommends that the sensors be calibrated regularly and at least once every 180 days (6 months).
- BW recommends to bump test the sensors before each day's use to confirm their ability to respond to gas by exposing the detector to a gas concentration that exceeds the alarm setpoints. Manually verify that the audible and visual alarms activate. Calibrate if the readings are not within the specified limits.
- Protect the combustible sensor from exposure to lead compounds, silicones, and chlorinated hydrocarbons. Although certain organic vapors (such as leaded gasoline and halogenated hydrocarbons) may temporarily inhibit sensor performance, in most cases the sensor will recover after calibration.
- BW recommends the combustible sensor be checked with a known concentration of calibration gas after any known exposure to catalyst contaminants/poisons (sulfur compounds, silicone vapors, halogenated compounds, etc).
- The combustible sensor is factory calibrated to 50% LEL methane. If monitoring a different combustible gas in the % LEL range, calibrate the sensor using the appropriate gas.
- **Warning:** High off-scale LEL readings may indicate an explosive concentration.

⚠ Cautions

- Only the combustible gas detection portion of this instrument has been assessed for performance by CSA International.
- For use only in potentially explosive atmospheres where oxygen concentrations do not exceed 20.9% (v/v).
- Any rapid upscaling reading followed by a declining or erratic reading may indicate a gas concentration beyond upper scale limit, which may be hazardous.
- Calibrate only in a safe area that is free of hazardous gas in an atmosphere of 20.9% oxygen.
- Use only BW approved batteries for the GasAlertQuattro detector. Refer to [Specifications](#).
- Charge the detector before first-time use. BW recommends the detector be charged after every workday.
- Charge the GasAlertQuattro using BW charger adapters designed for the GasAlertQuattro only. Do not use any other charging adapter. Failure to adhere to this caution can lead to fire and/or explosion.
- Extended exposure of the GasAlertQuattro to certain concentrations of combustible gases and air may stress a detector element, which can seriously affect its performance. If an alarm occurs due to high concentrations of combustible gases, recalibration should be performed, or if needed, the sensor replaced.
- Do not test the combustible sensor's response with a butane cigarette lighter; doing so will damage the sensor.
- Do not expose the detector to electrical shock or severe continuous mechanical shock.
- Deactivating the detector by removing the battery pack may cause improper operation and harm the detector.
- Do not immerse the detector in liquids.
- Do not attempt to disassemble, adjust, or service the detector unless instructions for that procedure are provided in this user manual and/or that part is listed as a replacement part. Use only BW Technologies by Honeywell [Replacement Parts and Accessories](#).

⚠ Cautions

- **Warning:** The lithium battery (QT-BAT-R01) may present a risk of fire or chemical burn hazard if misused. Do not disassemble, heat above 212°F (100°C), or incinerate.
- **Warning:** Do not use any other lithium batteries with the GasAlertQuattro detector. Use of any other cell can cause fire and/or explosion. To order and replace the QT-BAT-R01 battery, refer to [Replacement Parts and Accessories](#).
- **Warning:** Lithium polymer cells exposed to heat at 266°F (130°C) for 10 minutes can cause fire and/or explosion.
- Dispose of used lithium cells immediately. Do not disassemble and do not dispose of in fire. Do not mix with the solid waste stream. Spent batteries must be disposed of by a qualified recycler or hazardous materials handler.
- Keep lithium cells away from children.
- Calibration cylinders that are used with a demand flow regulator must meet the following maximum inlet pressure specifications:
 - Disposable cylinders 0-1000 psig/70 bar
 - Refillable cylinders 0-3000 psig/270 bar
- If using the detector near its upper or lower operating temperature, BW recommends zeroing or activating the detector in that environment.





⚠ Mises en garde

- **Avertissement** : Le remplacement d'un composant de l'appareil peut altérer sa sécurité intrinsèque.
- Avant toute utilisation du détecteur, reportez-vous à la section Sensor Poisons and Contaminants.
- **Avertissement** : Pour des raisons de sécurité, ce matériel doit être utilisé et entretenu exclusivement par du personnel qualifié. Lisez attentivement le présent guide technique avant d'utiliser l'appareil ou d'en assurer l'entretien, et assurez-vous d'en avoir bien compris les instructions.
- Ne pas utiliser le détecteur s'il est endommagé. Inspecter le détecteur avant de l'utiliser. Vérifier l'absence de fissures et/ou s'assurer qu'aucune pièce ne manque.
- Si le détecteur est endommagée ou si des pièces sont manquantes, prenez contact avec [BW Technologies by Honeywell](#) immédiatement.
- Utilisez uniquement des capteurs qui sont spécialement conçus pour le détecteur GasAlertQuattro. Reportez-vous à la section Replacement Parts and Accessories.
- Étalonnez le détecteur avant sa première utilisation, puis de manière régulière, en fonction de l'utilisation et de l'exposition du capteur aux poisons et autres contaminants. BW Technologies by Honeywell recommande d'étalonner les capteurs régulièrement et au moins une fois tous les 180 jours (6 mois).
- Avant chaque utilisation quotidienne, BW recommande d'effectuer un test fonctionnel des capteurs afin de vérifier qu'ils réagissent bien aux gaz présents, en exposant le détecteur à une concentration de gaz supérieure aux seuils d'alarme. Vérifiez manuellement que les alarmes sonore et visuelle sont activées. Étalonnez l'appareil si les mesures sont en dehors des limites spécifiées.
- Protégez le capteur de gaz combustibles contre toute exposition aux composés de plomb, aux silicones et aux hydrocarbures chlorés. Bien que certaines vapeurs organiques (telles que l'essence au plomb ou les hydrocarbures halogénés) puissent neutraliser provisoirement les performances du capteur, dans la plupart des cas, le capteur retrouvera son fonctionnement normal après étalonnage.
- BW recommande de contrôler le capteur de gaz combustibles à l'aide d'une concentration de gaz d'étalonnage connue après toute exposition à des poisons/contaminants catalytiques (composés de soufre, vapeurs de silicium, produits halogénés, etc.).
- Le capteur de gaz combustibles est étalonné en usine au méthane, à une concentration de 50 % de la LIE. Si la surveillance porte sur un autre gaz combustible dans la plage % LIE, étalonnez le capteur en utilisant le gaz approprié.

- **Avertissement** : Des valeurs LIE hors échelle élevées peuvent indiquer la présence d'une concentration explosive.
- Seul l'élément de détection de gaz combustibles de cet appareil a fait l'objet d'une évaluation des performances homologuée par CSA International.
- À utiliser exclusivement dans des atmosphères potentiellement explosives dans lesquelles la concentration d'oxygène ne dépasse pas 20,9 % (v/v).
- Une lecture qui augmente rapidement, puis qui baisse, ou une lecture fantaisiste peuvent être représentatives d'une concentration de gaz excédant la limite d'échelle supérieure et risquant donc d'être dangereuse.
- Veillez à effectuer l'étalonnage en zone sûre, exempte de gaz dangereux, dans une atmosphère contenant 20,9 % d'oxygène.
- Utilisez uniquement des batteries approuvées par BW pour le détecteur GasAlertQuattro. Reportez-vous à la section [Specifications](#).
- Chargez le détecteur avant sa première utilisation. BW recommande de recharger le détecteur après chaque journée d'utilisation.
- Chargez le détecteur GasAlertQuattro à l'aide d'adaptateurs pour chargeur de BW conçus uniquement pour le détecteur GasAlertQuattro. N'utilisez aucun autre adaptateur de charge. Le non-respect de cette consigne peut provoquer un incendie et/ou une explosion.
- L'exposition prolongée du détecteur GasAlertQuattro à certaines concentrations de gaz combustibles et d'air peut fortement solliciter un élément du détecteur et nuire gravement à ses performances. En cas d'apparition d'une alarme suite à de fortes concentrations de gaz combustibles, il faut effectuer un réétalonnage ou au besoin remplacer le capteur.
- Ne testez pas la réactivité du capteur de gaz combustibles avec un briquet au butane ; vous endommageriez le capteur.

- N'exposez pas le détecteur à des chocs électriques ou à de forts chocs mécaniques répétés.
- Toute désactivation du détecteur par le retrait de la batterie risque de l'endommager et de provoquer un fonctionnement inapproprié.
- N'immergez pas le détecteur dans des liquides.
- N'essayez pas de démonter, d'ajuster ou de réparer le détecteur, sauf si des instructions pour cette procédure sont fournies dans le présent guide technique de référence et/ou si la pièce concernée est répertoriée comme pièce de rechange. Utilisez uniquement ce que BW Technologies by Honeywell fournit en tant que Replacement Parts and Accessories
- **Avertissement** : La batterie au lithium (QT-BAT-R01) peut présenter un risque d'incendie ou de brûlure chimique en cas d'utilisation inappropriée. Veillez à ne jamais l'incinérer, la démonter ou l'exposer à une température supérieure à 100 °C.
- **Avertissement** : Veillez à ne jamais utiliser d'autres batteries au lithium avec le détecteur GasAlertQuattro. Toute autre batterie pourrait provoquer un incendie et/ou une explosion. Pour commander et réinstaller la batterie QT-BAT-R01, reportez-vous à la section Replacement Parts and Accessories.
- **Avertissement** : Les piles au lithium polymère exposées à une température supérieure à 130 °C (266 °F) pendant plus de 10 minutes peuvent provoquer un incendie et/ou une explosion.
- Mettez immédiatement au rebut les piles au lithium usagées. Veillez à ne jamais les démonter ou les jeter au feu. Ne les mélangez pas avec d'autres déchets solides. Les batteries usagées doivent être éliminées par un centre de recyclage agréé ou un centre de traitement des matières dangereuses.
- Gardez les piles au lithium hors de portée des enfants.
- Toutes les bouteilles d'étalonnage utilisées avec des régulateurs de débit à la demande doivent répondre aux spécifications de pression d'entrée maximale suivantes :
 - Bouteilles jetables de 0 à 1 000 psig/70 bars
 - Bouteilles rechargeables de 0 à 3 000 psig/270 bars
- Si vous utilisez le détecteur près de sa température de fonctionnement supérieure ou inférieure, BW recommande de mettre le détecteur à zéro ou de l'activer dans cet environnement.

Table 2. International Symbols

Symbol	Meaning	Symbol	Meaning
	Approved to both U.S. and Canadian Standards by CSA International	IECEX	International Electrotechnical Commission Scheme for Certification to Standards for Electrical Equipment for Explosive Atmospheres
	European Explosives Protection		Natural Institute of Metrology, Quality, and Technology. Conforms to Brazilian INMETRO Certification.
CE	Conforms to European Union Directives	ATEX	Conforms to European ATEX Directives
	Korean Testing Laboratory	EAC EX	Customs Union Russian Certification
	Australian Regulatory Compliance Mark		

Sensor Poisons and Contaminants

Several cleaners, solvents, and lubricants can contaminate and cause permanent damage to sensors. Before using cleaners, solvents, and lubricants in close proximity to the detector sensors, read the following caution and refer to [Table 3](#).

⚠ Caution

Use only the following BW Technologies by Honeywell recommended products and procedures:

- Use water-based cleaners.
- Use non-alcohol based cleaners.
- Clean the exterior of the detector with a soft, damp cloth.
- Do not use soaps, polishes, or solvents.

The following table lists common products to avoid using around sensors.

Table 3. Sensor Poisons and Contaminants

Cleaners and Lubricants	Silicones	Aerosols
Brake cleaners	Silicone cleaners and protectants	Bug repellents and sprays
Lubricants	Silicone based adhesives, sealants, and gels	Lubricants
Rust inhibitors	Hand/body and medicinal creams that contain silicone	Rust inhibitors
Window and glass cleaners	Tissues containing silicone	Window and glass cleaners
Dishsoaps	Mold releasing agents	
Citrus based cleaners	Polishes	
Alcohol based cleaners		
Hand sanitizers		
Anionic detergents		
Methanol (fuels and antifreezes)		

Getting Started

The list below provides the standard items included with the detector. If the detector is damaged or parts are missing, contact the place of purchase immediately.

- Sensors: H₂S, CO, O₂, and combustible LEL (depending upon sensors ordered with detector)

Note

Detectors that are configured for 1, 2, or 3 gases may contain a dummy sensor in one of the four sensor locations.

- Calibration cap
- Calibration hose (3 ft./1 m) w/ quick connect
- Charging adapter or 3 alkaline batteries (dependent on type of battery pack)
- Screwdriver
- Quick Reference Guide
- Supplementary booklet including a quick reference card
- Technical reference guide on CD-ROM

For a list of GasAlertQuattro accessories, refer to [Replacement Parts and Accessories](#).

Fleet Manager II Options

Fleet Manager II software can be downloaded without cost from BW Technologies by Honeywell's website www.gasmonitors.com.

Fleet Manager II CD-ROM is shipped with the MicroDock II base station.

The detector is shipped with the sensors and a rechargeable or alkaline battery pack. To replace sensors and maintain the battery pack, refer to the following:

- [Replacing the Sensors](#)
- [Charging the Rechargeable Battery](#)
- [Replacing the Battery Pack](#)
- [Replacing the Alkaline Batteries](#)

To order parts, refer to [Replacement Parts and Accessories](#).

To become oriented with the features and functions of the detector, refer to the following figures and tables:

- [Figure 1](#), and [Table 4](#), describes the detector's components.
- [Screen Elements](#) describes the LCD icons and screen elements.
- [Table 5](#), describes the detector's pushbutton.

Parts of the GasAlertQuattro

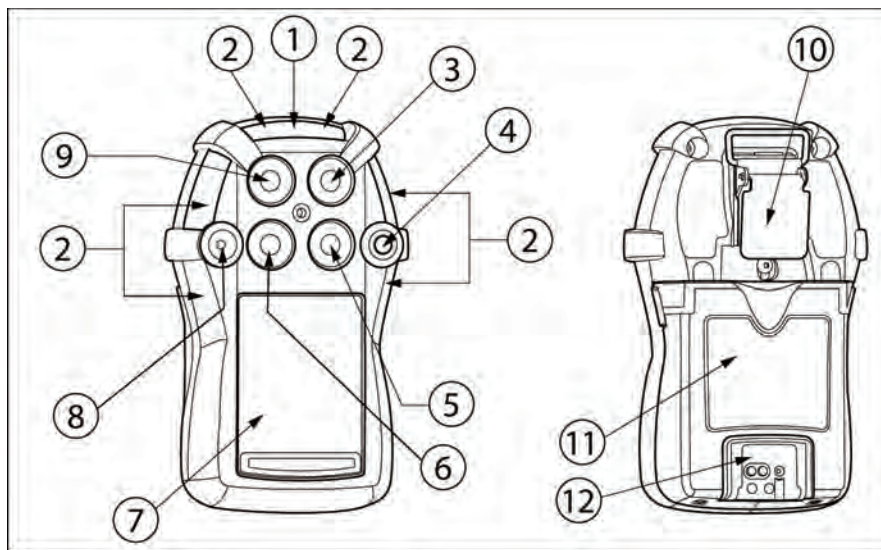

Figure 1. Parts of the GasAlertQuattro

Table 4. Parts of the GasAlertQuattro

Item	Description	Item	Description	Item	Description	Item	Description
1	IntelliFlash (green LED)	4	Button	7	Liquid crystal display (LCD)	10	Alligator clip
2	Visual alarm indicator (red LED)	5	Combustible (LEL) sensor	8	Audio alarm	11	Battery pack
3	Hydrogen sulfide (H ₂ S) sensor	6	Carbon monoxide (CO) sensor	9	Oxygen (O ₂)	12	Charging connector and IR interface

Screen Elements





























	Calibration gas cylinder		Display during startup to indicate audio and visual alarm pass or fail during a MicroDock II bump test		Displays if calibration is initiated and the Cal IR Lock option is enabled
	Bump test gas cylinder		Displays when the Stealth option is enabled		Displays during calibration and when startup is complete
	Indicates pass for startup, sensors, calibrations, and bump tests		Displays when the detector is in alarm (not applicable to TWA and STEL)		Battery — full charge
	Indicates fail for startup, sensors, calibrations, and bump tests		Displays when there is a warning, failure, error, or low battery		Battery — half charge
	Pushbutton displays when screen provides an option to end or skip		Heartbeat pulses continually during normal operation to verify the detector is operating correctly		Low battery warning
	Reading displays with white background during normal operation		Displays for STEL alarms and setpoints		Displays when the detector is connected to an IR Link
	Reading displays with alternating black background when the sensor is in alarm		Displays for TWA alarms and setpoints		Displays when the detector is communicating with Fleet Manager II
	Grey check box displays during bump tests or calibration when a gas is not due		Displays during peak gas exposure information screens		Displays when the detector's firmware is being updated
	Displays when the most recent calibration or bump test failed but a previous calibration or bump test is still valid within the due date. Also displays during auto-zero.		Displays during an operation such as auto-zeroing		Displays when gas should no longer be applied after a bump test or calibration

Table 5. Button

Button	Description
	<ul style="list-style-type: none"> • To activate the detector, press and hold ○ in a safe area that is free of hazardous gas and in an atmosphere of 20.9% oxygen. • To deactivate the detector, press and hold ○ during the powering off countdown. Release ○ when OFF displays. • To view the date/time, current battery power, calibration due date, bump test due date, TWA, STEL, and peak readings, press ○ twice rapidly. To clear the TWA, STEL, and peak readings, press and hold ○ when the LCD displays Hold ○ to reset peaks, TWA, STEL. • To initiate calibration, press and hold ○ while the detector performs the OFF countdown. Continue holding ○ while the LCD briefly deactivates and then reactivates to begin the calibration countdown. Release ○ when Calibration started displays. • To activate the backlight, press ○ and release. • To acknowledge latching alarms, press ○. • To acknowledge a low alarm and temporarily disable the audible alarm, press ○. The Low Alarm Acknowledge option must be enabled in Fleet Manager II. • To acknowledge any of the “due today” messages (calibration and bump test), press ○. If the force calibration option is enabled, a calibration cannot be bypassed. If the force bump option is enabled, a bump test cannot be enabled.

Activating/Deactivating the Detector

⚠ Caution

Only activate the detector in a safe area that is free of hazardous gas in an atmosphere of 20.9% oxygen.

Activate: Press and hold ○.

Deactivate: Press and hold ○ during the powering off countdown. Release ○ when **OFF** displays.

Startup Sequence

If an error screen displays during the startup sequence, refer to [Startup Troubleshooting](#).

When the detector is activated, it performs several tests during the startup sequence. Confirm the following tests occur.

Battery Test

If battery power is critically low upon startup, the detector displays the following screens and then deactivates.

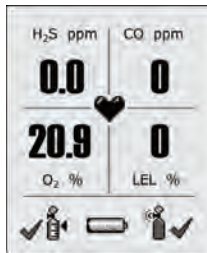

Recharge the battery for 6 hours. Refer to [Charging the Rechargeable Battery](#).

Segment Test

1. The segment test verifies that the visual, audio, and vibrate functions are operating correctly. The detector alarms, vibrates, and displays the following screen.



Product Identification and Firmware Revision

2. The following two screens display showing the BW and product identification, and the firmware revision.

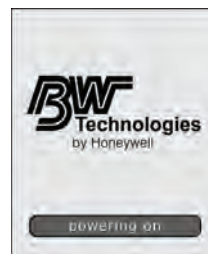

Startup Message

3. If data is entered in the Startup Message field in Fleet Manager II, a startup message (50 characters maximum) displays on the LCD. If a startup message has not been entered, it is bypassed during the startup sequence. Refer to [Startup Message](#) in User Options.



Note

To make a line break to force text to the next line, as in the example above, press the | (pipe or vertical bar) key.

Alarm Setpoints

4. The alarm setpoints defined in Fleet Manager II display on the detector in the following order:
 - TWA (time-weighted average) CO and H₂S only
 - STEL (short-term exposure limit) CO and H₂S only
 - Low
 - High

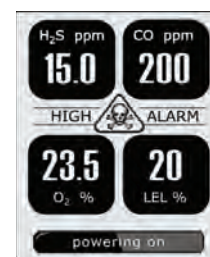
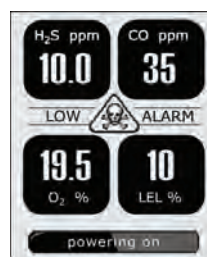
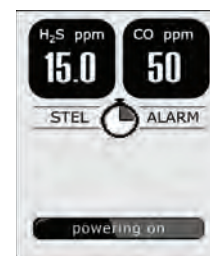
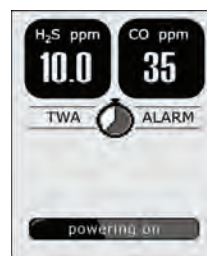

Note: Alarm setpoints may vary by region. Refer to [Sample Gas Alarm Setpoints](#).

Sensor Self Test

The detector tests the sensors during startup. If all sensors pass, the following screen displays.



If all sensors fail the startup sensor self-test, the following screens display.

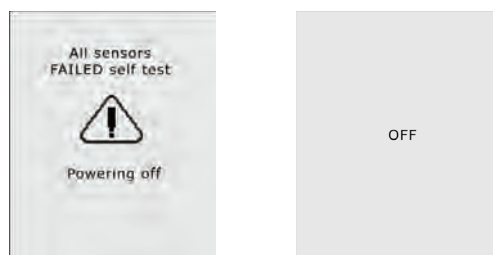

Lockout Enabled

If **Lockout on Self-test Error** is enabled and a sensor fails the startup sensor self-test, the following screens display.

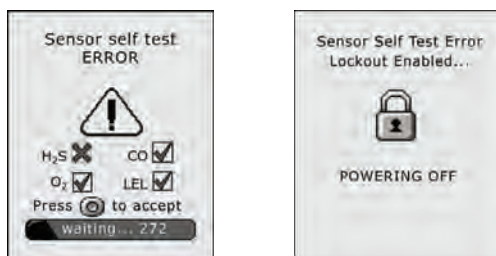

OFF then displays and the detector deactivates. For all sensor and self-test error screens, refer to [Startup Troubleshooting](#).

The detector then automatically deactivates.

For all sensor and self-test error screens, refer to [Startup Troubleshooting](#).

Lockout Disabled

If **Lockout on Self Test Error** is disabled and a sensor fails the self-test, the following screens display.

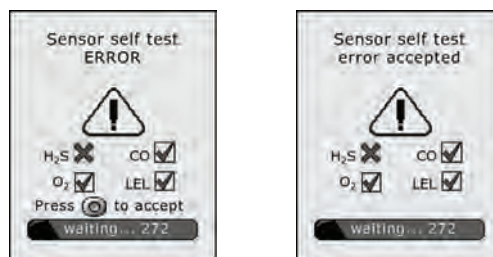



BW Technologies by Honeywell recommends that the sensor be replaced immediately. Refer to [Replacing the Sensors](#).

Auto Zero Sensors

- The detector zeros the sensors.

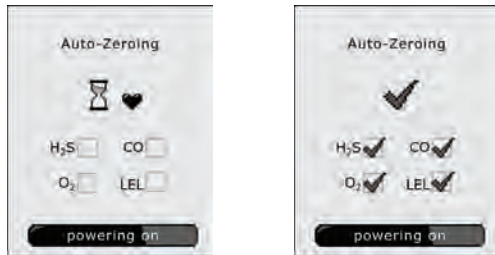
When auto-zeroing is complete,  changes to .



If a sensor fails the auto-zero test, the Auto-zero error screen displays.  indicates which sensor failed and that a previous auto-zero result for that sensor will be used to zero the sensor.



For sensor error causes, refer to [Startup Troubleshooting](#).

Next Calibration Due

- The next calibration due date for each sensor displays.

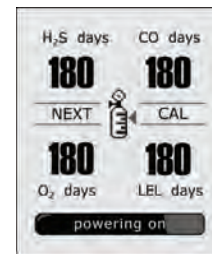

Note

N/A displays when the calibration interval has been defined as 0 days. Refer to [Calibration Interval](#).

⚠ Warning

BW Technologies by Honeywell recommends that the sensors be calibrated regularly and at least once every 180 days (6 months).

Sensors Due for Calibration

If calibration is due, the following screen displays. **X** flashes for each sensor that is due for calibration.

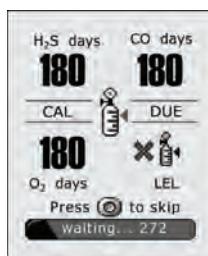

Press to acknowledge that calibration is due. If **Force Calibration** is disabled, the detector enters normal operation.

If the **Force Calibration** option is enabled, the following screen displays.

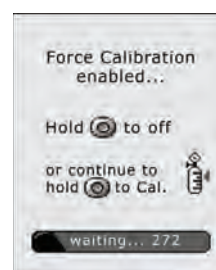

The sensor(s) must be calibrated to enter normal operation. Press and hold to enter calibration and refer to [Calibration Procedures](#), or press and release to deactivate the detector.

Note

BW Technologies by Honeywell recommends that the sensors be calibrated at least once every 180 days (6 months).

Bump Test Due

7. The next bump test due date for each sensor displays.

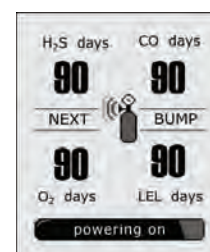

Sensors Due for Bump Test

If a bump test is due, the following screen displays. **X** flashes for each sensor that is due for a bump test.

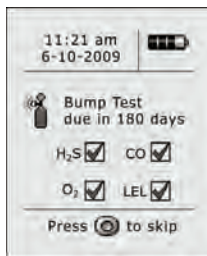

Note

N/A displays when the bump test interval has been defined as 0 days. Refer to [Bump Interval](#).

⚠ Caution

BW recommends to bump test the sensors before each day's use to confirm their ability to respond to gas by exposing the sensors to a gas concentration that exceeds the alarm setpoints.

Press **X** to acknowledge that a bump test is due. If **Force Bump** is disabled, the detector enters normal operation.

Force Bump Test Enabled: If the **Force Bump** option is enabled, the following screen displays.

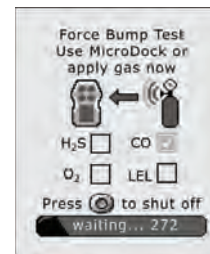

The sensor(s) must pass the bump test to enter normal operation.

Apply gas manually or via the MicroDock II station, or press **X** to exit and deactivate the detector. Refer to [Bump Test](#).

Note

BW Technologies by Honeywell recommends to bump test the sensors before each day's use to confirm their ability to respond to gas by exposing the sensors to a gas concentration that exceeds the alarm setpoints. Manually verify that the audible and visual alarms activate. Calibrate if the readings are not within the specified limits.

If error screens display, refer to [Bump Test Troubleshooting](#).

Startup Self-test Summary

8. The detector performs several diagnostic tests during startup to ensure it is operating correctly. A checkmark displays for each test that has passed successfully.



If **X** displays for Hardware, Battery, Sensors, Clock, or Memory contact [BW Technologies by Honeywell](#). If an **X** displays Auto-Zero, the detector uses the previous zero readings. The detector can be zeroed in a safe area free of hazardous gas. Refer to steps #1-9 in [Quad Gas Calibration](#).

The detector enters normal operation.

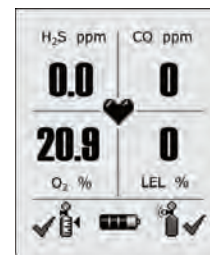

The detector automatically begins

- recording the peak gas exposure,
- calculating the short-term exposure level (STEL), and
- calculating the time-weighted average (TWA) exposures.

Installing Fleet Manager II

Fleet Manager II is required to configure the detector. To install Fleet Manager II, refer to the Fleet Manager II CD-ROM that includes the

- installation wizard, and
- *Fleet Manager II Quick Reference Guide* (located under **Help**).

In Fleet Manager II there are two sections to add data, enable/disable features, and to define settings for the sensors and the detector:

- [Device Configuration](#)
- [Sensor Configuration](#)

Using Fleet Manager II to Configure the Detector

When Fleet Manager II is installed, refer to [Table 6.](#), [Figure 2.](#), and the following procedures:

Table 6. Connecting the IR Link

Item	Description
1	Detector
2	IR and charger interface
3	IR Link
4	USB cable

Note

The detector can also be configured with the MicroDock II. Refer to the Fleet Manager II Quick Reference Guide.

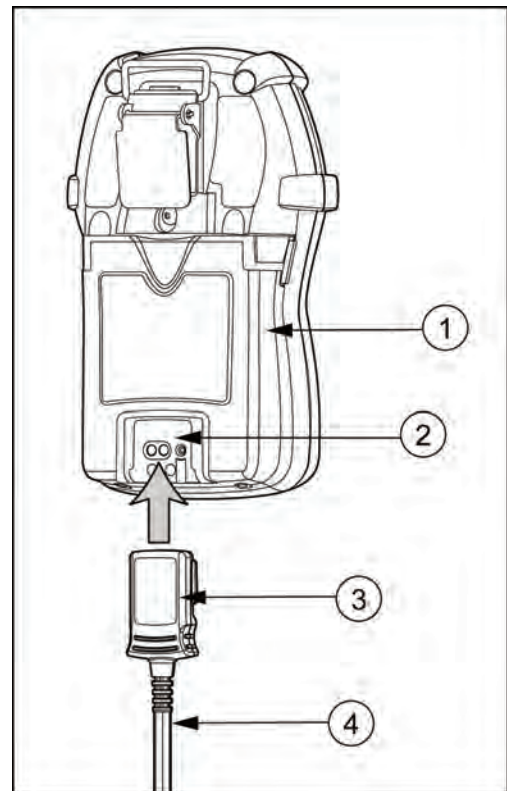

Figure 2. Connecting the IR Link

1. Activate the detector and wait for the startup sequence to complete.
2. Connect the USB cable to the USB port on the computer.

Note

Plug the USB into the same USB port where the USB drivers were installed.

3. Connect the USB cable to the IR Link.
4. Insert the IR Link into the IR interface on the back of the detector.
5. From the PC, open Fleet Manager II.
6. Click **Administration**.
7. From the **Administration** toolbar, click **Login / Logout** to access the **Enter Password** dialog box. Enter **Admin** and click **OK** (password is case sensitive).
8. From the **Devices** toolbar, click **Configure Device via IR Link**.
9. The **Device Selection** popup displays. Select **GasAlertQuattro** and click **OK**.
10. From the configuration window, click **Retrieve from Device** at the bottom of the window. The fields automatically populate with the detector's current configuration settings.
11. Refer to the following sections in this manual for descriptions about how to enter data, enable/disable, and define settings.
12. When all settings are defined, click **Save to Device** at the bottom of the window. The detector is now updated with the new settings.

Device Configuration

The **Device Configuration** section displays data about the detector, allows for a startup message to be entered, and defines and enables/disables settings for the detector.

Setting	Value
Serial Number	
Firmware Version	
Hardware Version	
Startup Message	
Lockout on Self-Test Error	<input type="checkbox"/>
Safe Mode	<input type="checkbox"/>
Stealth Mode	<input type="checkbox"/>
Flip Display	<input type="checkbox"/>
Force Bump	<input type="checkbox"/>
Force Calibration	<input type="checkbox"/>
Cal IR Lock	<input type="checkbox"/>
Latching Alarms	<input type="checkbox"/>
IntelliFlash	<input checked="" type="checkbox"/>
Confidence/Compliance Beep	<input type="checkbox"/>
Confidence/Compliance Beep Interval (seconds)	10
IntelliFlash Interval (seconds)	1
Datalog Interval (seconds)	15
Language	English

Figure 3. Device Configuration via IR Link

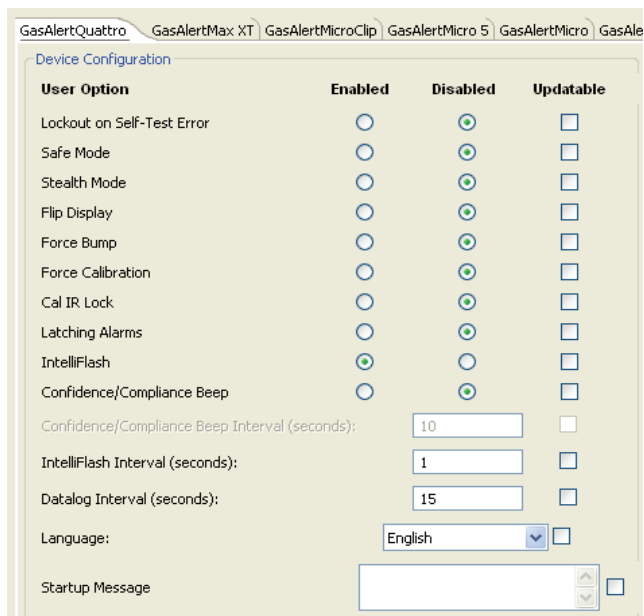

Figure 4. Device Configuration via MicroDock II

Refer to the following options to define settings for the detector.

Note

When options are enabled/disabled, the checkbox displays with a red frame until the new settings are saved to the detector. Click **Save to Device** and then click **Retrieve from Device** to remove the red frames.

Serial Number Field

This field displays the serial number (e.g. **QA109-001000**) of the detector.

Note

The Serial Number, Firmware Version, and Hardware Version fields are read-only fields. Settings for these fields are factory defined.

Firmware Version

This field displays the current firmware version that displays on the detector LCD during the startup sequence. If new firmware is uploaded to the detector, the **Firmware Version** field automatically updates.



Hardware Version

This field displays the current hardware version of the detector.

Startup Message

Enter text to display on the detector LCD during startup (50 characters maximum). Enter information such as employee name, plant, area, emergency number(s), etc.



Note

To make a line break to force text to the next line, as in the example above, press the | (pipe or vertical bar) key.

Lockout on Self-Test Error

If **Lockout on Self-Test Error** is enabled and a failure occurs during the self-test, the following screen displays and the detector deactivates.

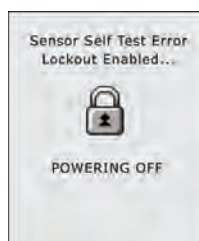

To enter normal operation, the sensor must be operating correctly. Refer to [Troubleshooting](#) and [Replacing the Sensors](#).

The detector is shipped with **Lockout on Self-Test Error** disabled.

Safe Mode

If enabled, **SAFE** displays continuously on the LCD unless an alarm condition occurs.



If an alarm occurs, the LCD displays the alarm condition and the real-time readings for each sensor.

Confidence/Compliance Beep

If enabled, the Confidence/Compliance Beep provides continuous audible confirmation that the detector is operating correctly. Frequency of the beep is defined with the [Confidence/Compliance Beep Interval](#) option (every 1-120 seconds).

Note

Confidence/Compliance Beep automatically disables during a low battery alarm, self-test fail, calibration fail, bump test fail, and when an alarm event occurs.

GasAlertQuattro User Manual

The detector is shipped with the **Confidence/Compliance** Beep option disabled.

Latching Alarms

If enabled, during an alarm condition the **Latching Alarms** option causes the low and high gas alarms (audible, visual, and vibrator) to persist until the alarm is acknowledged and the gas concentration is below the low alarm setpoint. The LCD displays the peak concentration until the alarm no longer exists. Local regulations in your region may require the **Latching Alarms** option be enabled.

The detector is shipped with the **Latching Alarms** option disabled.

Force Calibration

Calibration is performed to adjust the sensitivity levels of the sensors to ensure accurate responses to gas.

If enabled and a sensor(s) is past due for calibration, the following screen displays during the startup self-tests.

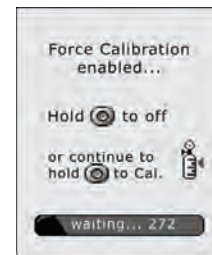

The sensor(s) must be calibrated to continue and enter normal operation. Press and hold , and refer to [Calibration Procedures](#).

Or

Press and release to deactivate the detector.

A value must be entered in the **Cal Interval (days)** field in the Sensor Configuration section before enabling **Force Calibration**.

⚠ Caution

If 0 (zero) is entered in the Cal Interval (days) field, the Force Calibration option is automatically disabled.

The detector is shipped with the **Force Calibration** option disabled.

Force Bump

A bump test should be performed regularly to ensure the sensor(s) are responding correctly to gas. If enabled **Force Bump** and the sensor(s) is past due, a bump test should be performed and the overdue sensor(s) must enter into alarm. If the **Force Bump** option is enabled, the following screen displays during the startup sequence.

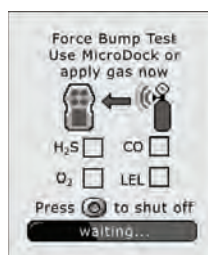

If enabled, the detector continues to prompt until a bump test is performed and the sensor passes. Apply gas to initiate a bump test.

Or

Press and hold  to deactivate the detector.

A value must be entered in the **Bump Interval (days)** field in the Sensor Configuration section before enabling **Force Bump**.

Caution

If 0 is entered in the **Bump Interval (days)** field, the **Force Bump** option is automatically disabled.

Note

BW recommends to bump test the sensors before each day's use to confirm their ability to respond to gas by exposing the detector to a gas concentration that exceeds the alarm setpoints. Verify that the audible and visual alarms activate. Calibrate if the readings are not within the specified limits.

For complete instructions to perform a bump test, refer to [Bump Test](#).

The detector is shipped with the **Force Bump** option disabled.

Cal IR Lock

If enabled, the sensor(s) can only be calibrated using an IR device (IR Link or the MicroDock II station).

If the **Cal IR Lock** option is enabled and calibration is due, the following screen displays.



Note

*If the **Cal IR Lock** option is enabled and a manual calibration is attempted, the sensor(s) will auto zero but they will not be calibrated.*

Depending upon the IR device used to calibrate, refer to one of the following:

- [Calibrating Using an IR Device](#), or
- *MicroDock II Base Station User Manual*

The detector is shipped with the **Cal IR Lock** option disabled.

Flip Display

The detector can display screens at 0° (upright) or 180° (upside down), depending upon how the detector is worn by the worker. If the **Flip Display** option is enabled, the LCD is viewed at 180° (upside down).

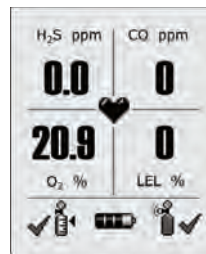

Disabled (0°)

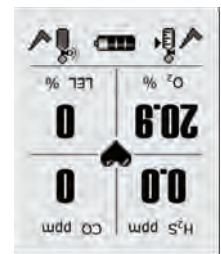

Enabled (180°)

The detector is shipped with the **Flip Display** option disabled (upright).

Stealth

When the **Stealth** option is enabled, the following features are disabled:

- backlight,
- audible alarms,
- visual alarms,
- IntelliFlash, and
- confidence/compliance beep

Only the vibrator and the LCD readings activate during an alarm condition.

When **Stealth** is enabled,  displays every 3 seconds between each sequence of three heartbeats.

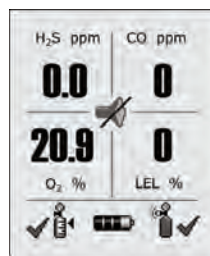

If an alarm occurs,  ceases to display until the gas concentrations are below the low alarm setpoint.

The detector is shipped with the **Stealth** option disabled.

Datalog Interval

The **Datalog Interval (seconds)** field defines how often the detector records a datalog (every **1-120** seconds). Enter the desired value.

The total number of 8-hour days datalogs that can be recorded is assuming 90% of the day has no gas concentrations.

Datalog Interval	Total Number of Days Datalogs Can Be Recorded
5 seconds	up to 15 days
15 seconds	up to 45 days
60 seconds	up to 180 days

When the memory is full, the detector replaces the oldest datalogs with the most recent datalogs.

The detector is shipped with the default setting of **5** seconds.

IntelliFlash Interval

The **IntelliFlash Interval (seconds)** field defines how often (every **1-120** seconds) the IntelliFlash occurs. Enter the desired value.

The detector is shipped with the default setting of **1** second for the **IntelliFlash Interval** option.

Confidence/Compliance Beep Interval

The Confidence/Compliance Beep Interval field defines how often (every **1-120** seconds) the confidence/compliance beep occurs. Enter the desired value.

The detector is shipped with confidence/compliance beep disabled.

Language

The **Language** field provides a drop down menu that includes the following language options:

- **English**
- **Français** (French)
- **Deutsch** (German)
- **Español** (Spanish)
- **Português** (Portuguese)

From the drop down menu, select the required language. When the settings are saved to the detector, the LCD displays all screens in the selected language.

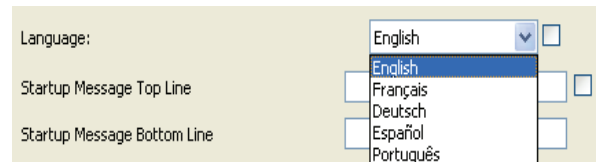

The detector is shipped with **English** displaying as the default language.

Sensor Configuration

The **Sensor Configuration** tab defines settings for each individual sensor. A separate sensor tab is provided for each sensor. [Figure 6](#) shows the available option settings for the CO sensor.

Note

Depending upon the sensor, the options may vary.

Figure 5. Sensor Configuration Tab (CO) via MicroDock II

Figure 6. Sensor Configuration Tab (CO) via IR Link

Sensor Disabled

⚠ Warning

Use extreme caution when disabling a sensor. The disabled sensor cannot detect and alarm against the applicable gas.

The detector is shipped with all sensors enabled.

GasAlertQuattro User Manual

To disable a sensor, complete the following:

1. Click **Retrieve from Device** to populate the fields with the current detector settings.
2. Click the tab of the sensor to be disabled.
3. Click the **Sensor Disabled** checkbox.

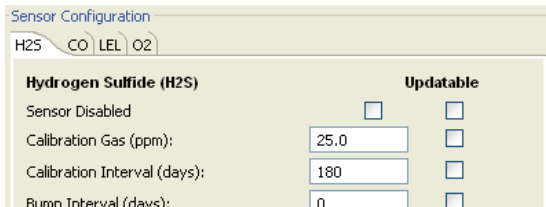

Figure 7. Sensor Configuration Tab (H₂S) via MicroDock II

4. Click **Save to Device** located at the bottom of the window.

Note

When options are enabled/disabled, the checkbox displays with a red frame until the new settings are saved to the detector. Click **Save to Device** and then click **Retrieve from Device** to remove the red frames.

5. The LCD automatically updates. In the following example, the CO gas type and sensor readings no longer display.

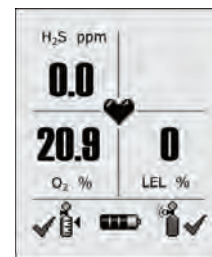

Calibration Gas (ppm)

⚠ Warning

The gas concentration value entered in Fleet Manager II must match the gas concentration value on the gas cylinder.

1. Select the applicable sensor tab.
2. Enter the gas concentration value in the **Calibration Gas (ppm)** field for H₂S and CO.
3. Enter the gas concentration value in the **Calibration Gas (%)** field for O₂ and LEL.

Note

The gas concentration value for the O₂ sensor must be calibrated with a % value other than 20.9% or 20.8%. The O₂ calibration gas concentration must be between 10% to 19%.

Calibration Interval

Define how often a sensor should be calibrated in the **Calibration Interval (days)** field. A different calibration interval can be defined for each sensor.

1. Enter the value (**0-365** days) for each sensor.
2. Enter **0** to disable the calibration interval option. Entering **0** automatically deactivates the **Force Calibration** option. The detector is shipped with the factory default setting of **180** days.

Caution

BW recommends that the sensors be calibrated at least once every 180 days (6 months).

Bump Interval

Define how often a bump test should be performed for each sensor in the **Bump Interval (days)** field. A different bump interval can be defined for each sensor.

1. Enter the value (**1-365** days) for each sensor.
 2. Enter **0** to disable the bump interval option. Entering **0** automatically deactivates the **Force Bump** user option.
- The detector is shipped with the **Bump Interval** default setting of **0** days.

Note

BW recommends to bump test the sensors before each day's use to confirm their ability to respond to gas by exposing the detector to a gas concentration that exceeds the alarm setpoints. Verify that the audible and visual alarms activate. Calibrate if the readings are not within the specified limits.

Low Alarm

Define the low alarm setpoints for each sensor. Refer to [Sample Gas Alarm Setpoints](#) for factory defined alarm setpoints.

High Alarm

Define the high alarm setpoints for each sensor. Refer to [Sample Gas Alarm Setpoints](#) for factory defined alarm setpoints.

TWA Alarm

The time-weighted average (TWA) is a safety measure used to calculate accumulated averages of gases. Using the US Occupational Safety and Health Administration (OSHA) method or the American Conference of Governmental Hygienists (ACGIH) method, an average is calculated to ensure the detector alarms when the TWA has accumulated.

OSHA: The US OSHA method is defined as a moving average that accumulates over an 8-hour average. If the worker is in the field longer, the oldest accumulated values (first hour) are replaced by the newest values (ninth hour). This continues for the duration of the work shift until the detector is deactivated.

ACGIH: The ACGIH method is defined as the infinite (total) accumulated average, whether it is 2 hours or 8 hours.

1. Refer to [Sample Gas Alarm Setpoints](#) for sample factory alarm setpoints.
2. Enter the TWA alarm setpoint for the H₂S and CO sensor in the **TWA Alarm (ppm)** field (not applicable to O₂ and LEL sensors).

3. Enter a value (**4-16** hours) in the **TWA Period (hours)** field to define the duration of the moving average. For more information, refer to [TWA Period \(hours\)](#).

STEL Alarm

The short-term exposure limit (STEL) is the maximum permissible gas concentration a worker can be safely exposed to for short periods of time (5-15 minutes maximum).

Note

Standard factory alarm setpoints may vary by region. Refer to [Sample Gas Alarm Setpoints](#) for US OSHA factory settings.

1. Refer to the applicable regulatory requirements in your area for defining STEL alarm setpoints.
2. Enter the STEL setpoint for the H₂S and CO sensors in the **STEL Alarm (ppm)** field (not applicable to O₂ and LEL sensors).
3. Enter a value (**5-15** minutes) in the **STEL Interval (minutes)** field to define the short-term exposure limit. For more information refer to [STEL Interval](#).

Correction Factor (LEL)

The **Correction Factor** option defines compensation factors for hydrocarbons other than methane. The correction factor is only applicable to LEL and can only be applied if the LEL sensor has been calibrated with methane.

The correction factor that is entered in Fleet Manager II displays during the startup self-tests.

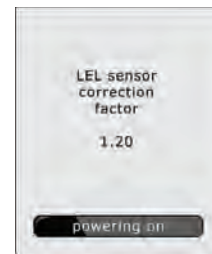

STEL Interval

The **STEL Interval** option provides protection for workers from over exposure to high concentrations of gas, and is based on user-defined 5-15 minute intervals. When the maximum STEL is reached, the detector alarms to notify the worker.

⚠ Caution

Follow all safety procedures as defined by your employer.

Enter the interval (**5-15** minutes) in the **STEL Interval (minutes)** field. The detector is shipped with a default setting of **15** minutes.

TWA Period (hours)

The **TWA Period (hours)** option calculates a time-weighted moving average of accumulated gases over a period of 4-16 hours, to ensure the detector alarms when the defined maximum average is accumulated.

Example: The **TWA Period option** is set to **8** hours. Therefore, the moving average accumulates over a 8-hour average. If the worker is in the field longer, the oldest accumulated values (first hour) are replaced by the newest values (ninth hour). This continues for the duration of the work shift until the detector is deactivated.

Note

Regulations may vary depending upon region. Adhere to the regulations defined for your area.

Enter the period (**4-16** hours) in the **TWA Period (hours)** field. The detector is shipped with a default setting of **8** hours.

TWA Method

The **TWA Method** defines the TWA calculating method. Select either the US Occupational Safety and Health Administration (OSHA) or the American Conference of Governmental Industrial Hygienists (ACGIH) TWA TWA calculating method. The detector is shipped with the default method as US OSHA.

- US OSHA Method: 8 hour moving average
- ACGIH Method: Infinite accumulated average to 8 hours

50% LEL = (%CH4)

A percentage value can be entered in the **50% LEL = (%CH4)** field to display the LEL reading in **%vol.** assuming a methane environment. The **LEL By Volume CH4** option must be enabled to apply the value.

Enter the equivalent methane concentration for 50% LEL as follows:

- North America = 2.5%
- Europe = 2.2%

This option is only applicable to the LEL sensor.

The detector is shipped with a default setting of **2.5%** v/v methane 50% LEL.

Note

If 50% LEL = (%CH4) is enabled, LEL alarm setpoints still defined in % LEL.

Auto Zero on Startup

When enabled, the sensors automatically zero during the startup sequence. The **Auto Zero on Startup** option is available for the CO, H₂S, LEL, and O₂ sensors (each sensor is enabled individually).

The detector is shipped with the **Auto Zero on Startup** option enabled for all sensors.

LEL by Volume CH4

If enabled, the detector displays the LEL value as **%vol.** assuming a methane environment.

If **LEL by Volume CH4** is enabled, a percentage value must be entered in the **50% LEL = (%CH4)** field. Refer to [50% LEL = \(%CH4\)](#) (applicable to LEL sensor only).

The detector is shipped with the **LEL by Volume CH4** option disabled.

10% LEL (of reading) Over-span

If enabled, the detector automatically over-spans the LEL sensor by 10% of the span concentration. Enable **10% LEL (of reading) Over-Span** to ensure the detector is in compliance with CAN/CSA C22.2 No. 152.

The detector is shipped with the **10% LEL (of reading) Over-Span** option disabled.

20.8 Base Reading

If the **20.8 Base Reading** option is enabled, the detector assumes 20.8 % O₂ as ambient air (factory default is 20.9% O₂). Applicable to the O₂ sensor only.

The detector is shipped with the **20.8 Base Reading** option disabled.

Low Alarm Acknowledge

If the **Low Alarm Acknowledge** option is enabled, the audible alarm can be disabled during a low alarm condition. The LED and visual alarm indicators remain active until the alarm condition changes or the detector deactivates. Press to acknowledge the low alarm and deactivate the audible alarm. If the alarm escalates to a high, TWA, or STEL alarm, the audible alarm reactivates.

Note

*The **Low Alarm Acknowledge** option is not applicable to O₂.*

The detector is shipped with the **Low Alarm Acknowledge** disabled for all sensors.

Alarms

[Table 7](#), describes the detector alarms and corresponding screens.

During an alarm condition, the detector activates the backlight, audible/visual/vibrator alarms (only vibrator when **Stealth** is enabled) and displays the current ambient gas reading. If more than one type or level of alarm exists simultaneously, a multi-gas alarm results.

To change the factory-defined alarm setpoints, refer to [Low Alarm](#), [High Alarm](#), [TWA Alarm](#), and [STEL Alarm](#) in [Device Configuration](#).

Table 7. Alarms

Alarm	Screen	Alarm	Screen
<p>Low Alarm</p> <ul style="list-style-type: none"> • Slow siren (upward tone) • Slow flash • Black box around gas flashes • Vibrator alarm activates 		<p>TWA Alarm</p> <ul style="list-style-type: none"> • Fast siren (downward tone) • Fast flash • Black box around gas flashes • Vibrator alarm activates 	
<p>High Alarm</p> <ul style="list-style-type: none"> • Fast siren (downward tone) • Fast flash • Black box around gas flashes • Vibrator alarm activates 		<p>STEL Alarm</p> <ul style="list-style-type: none"> • Fast siren (downward tone) • Fast flash • Black box around gas flashes • Vibrator alarm activates 	

Table 7. Alarms



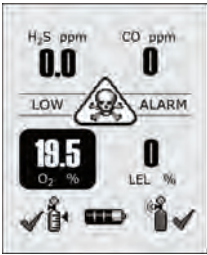
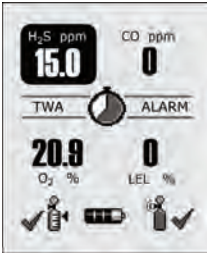
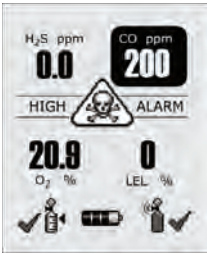
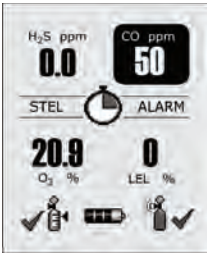

Alarm	Screen	Alarm	Screen
<p>Multi-Gas Alarm</p> <ul style="list-style-type: none"> • Alternating low and high alarm siren and flash • Black box around gas flashes • Type of alarm alternates • Vibrator alarm activates 		<p>Over Limit (OL) Alarm</p> <ul style="list-style-type: none"> • Fast siren (downward tone) • Fast flash • Black box around gas flashes • Vibrator alarm activates <p><i>Note: LCD may also display an under-limit reading (-OL)</i></p>	
<p>Low Battery Alarm</p> <ul style="list-style-type: none"> • Sequence of 10 rapid sirens and alternating flashes with 7 seconds of silence in between (continues for 15 minutes) • Battery icon flashes and the vibrator activates • After 15 minutes, of the low battery alarm sequence, the detector enters critical battery alarm. Refer to Critical Battery Alarm. 		<p>Critical Battery Alarm</p> <ul style="list-style-type: none"> • Fifteen minutes after the low battery alarm activates, a sequence of 10 rapid sirens and alternating flashes with 1 second of silence in between (sequence reactivates seven times) • Vibrator alarm pulses • Low Battery Powering Off displays and the detector deactivates 	

Table 7. Alarms

Alarm	Screen	Alarm	Screen
<p>Heartbeat</p> <ul style="list-style-type: none"> •  pulses every second to verify detector is operating correctly. 		<p>Normal Deactivation</p> <ul style="list-style-type: none"> • Sequence of alternating beeps and flashes • Vibrator alarm activates • Countdown initiates • OFF displays 	
<p>IntelliFlash</p> <ul style="list-style-type: none"> • One flash (green LED) every 1-120 seconds (flash frequency is defined with the IntelliFlash Interval option) <p><i>Note: IntelliFlash automatically deactivates during a low battery alarm, calibration fail, bump test fail, self-test fail, and an alarm condition.</i></p>		<p>Sensor Failure Alarm</p> <ul style="list-style-type: none"> •  displays 	

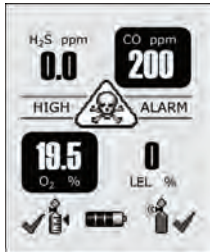
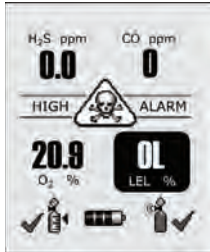
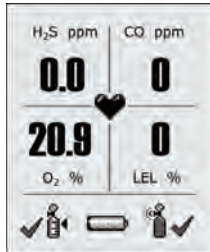
GasAlertQuattro
User Manual

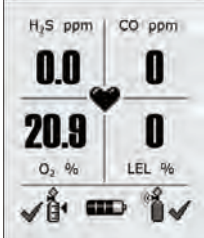
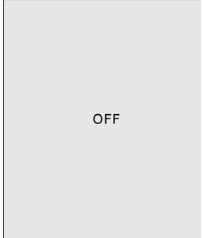
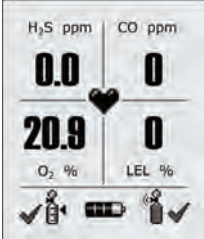
Alarm	Screen	Alarm	Screen
<p>Confidence/Compliance Beep</p> <ul style="list-style-type: none"> One beep every 1-120 seconds (beep frequency is defined with Confidence/Compliance Beep Interval option) <p><i>Note: (Confidence/compliance beep automatically deactivates during a low battery alarm, calibration fail, bump test fail, self-test fail, and an alarm condition.</i></p>		<p><i>Note: If Low Alarm Acknowledge is enabled, the audible alarm can be disabled during a low alarm condition. The visual, audible, and vibrate alarms remain active until the alarm condition changes or the detector deactivates. Press \bigcirc to acknowledge and deactivate the audible alarm. If the alarm escalates to a high, TWA, or STEL alarm, the audible alarm reactivates.</i></p> <p><i>If enabled, during an alarm condition Latching Alarms causes the low and high gas alarms (audible, visual, and vibrator) to persist until the alarm is acknowledged by pressing \bigcirc and the gas concentration is below the low alarm setpoint. The peak concentrations display continually until the alarm condition no longer exists. Local regulations may require Latching Alarms be enabled.</i></p>	

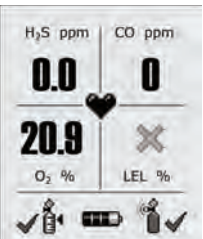
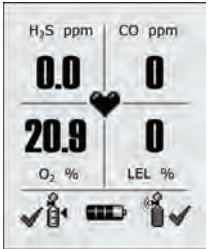
Stopping a Gas Alarm

The low and high alarms stop when the ambient gas concentration returns to the acceptable range.

Note

If alarms are set to latch, press  to reset the alarms.

The TWA and STEL alarms can be stopped either by

- deactivating and then reactivating the detector, or
- clearing the TWA/STEL/peak exposure readings. Refer to [Viewing and Clearing Gas Exposures](#).

⚠ Warning

Follow all safety procedures as defined by your employer. Confirm with your supervisor before clearing TWA and STEL alarms.

Computed Gas Exposures

⚠ Warning

To prevent possible personal injury, do not deactivate the detector during a work shift. TWA, STEL, and peak readings reset when the detector is deactivated.

Table 8. Computed Gas Exposures

Gas Exposure	Description
TWA (H ₂ S and CO only)	Time-weighted average (TWA) based on accumulated exposure to toxic gases averaged over a work-day according to US OSHA or ACGIH TWA method. Refer to TWA Method and TWA Period (hours) . Default: US OSHA 8 hour moving average. User-defined TWA Period: 4-16 hour moving average.
STEL (H ₂ S and CO only)	Short-term exposure limit (STEL) to gas based on a 5-15 minute user-defined period.
* Peak	Peak concentration encountered during a work shift.

* For oxygen, it is the highest or the lowest concentration encountered.

Viewing and Clearing Gas Exposures

To view the TWA, STEL, and peak readings, press **○** twice rapidly.

1. The LCD first displays the
 - current time and date,
 - battery capacity, and
 - the due dates for the next calibration.

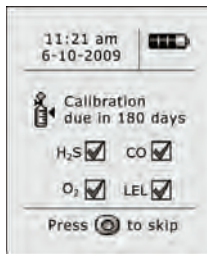

2. Next, the due date for the next bump test displays.

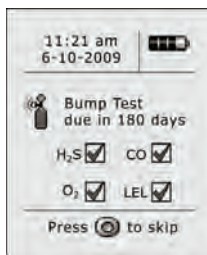

3. Next, the TWA, and STEL gas exposures display.

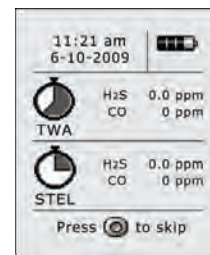

4. Next, the peak gas exposures screen displays.

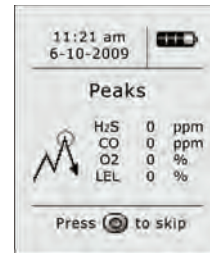

5. Last, the **Hold ○** button to reset peaks screen displays.

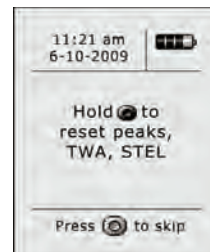

Press and release to return to normal operation or press and hold to reset peak readings.

⚠ Warning

Follow all safety procedures as defined by your employer. Deactivating the detector clears all readings. Confirm with your supervisor before clearing TWA and STEL alarms.

Cancel Resetting Peak Readings: If is pressed and released or is not pressed when the **Hold button to reset peaks** screen displays, the following screen displays.

6. If is held to reset the peak readings, the following screen displays.

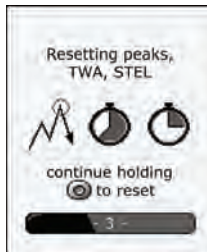
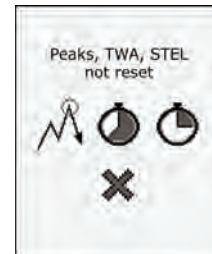

Continue holding until the following screen displays.

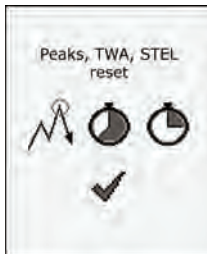

Gas Alarm Setpoints

Gas alarms are activated when detected gas concentrations are above or below the user-defined setpoints. The gas alarms are described in [Table 9](#).

Table 9. Gas Alarm Setpoints

Alarm	Condition
Low	<i>Toxics and combustibles:</i> Ambient gas level above low alarm setpoint. <i>Oxygen:</i> Ambient gas level may be set above or below 20.9% (or 20.8%).
High	<i>Toxics and combustibles:</i> Ambient gas level above high alarm setpoint. <i>Oxygen:</i> Ambient gas level may be set above or below 20.9% (or 20.8%).
TWA	<i>Toxics only:</i> Accumulated value above the TWA alarm setpoint.
STEL	<i>Toxics only:</i> Accumulated value above the STEL alarm setpoint.
Multi-gas	Two or more gas alarm conditions simultaneously.
Over Limit (OL)	OL or -OL displays when readings are above or below the sensor detection range, respectively. Refer to Specifications for detection ranges.

Sample Gas Alarm Setpoints

[Table 10](#) lists alarm setpoints as defined by the US Occupational Safety and Health Association (OSHA).

Note

Standard factory alarm setpoints may vary by region.

Table 10. Sample Factory Alarm Setpoints

Gas	TWA	STEL	Low	High
H2S	10 ppm	15 ppm	10 ppm	15 ppm
CO	35 ppm	50 ppm	35 ppm	200 ppm
O2	N/A	N/A	19.5% vol.	23.5% vol.
LEL	N/A	N/A	10% LEL	20% LEL

Note

To disable an alarm, set the alarm setpoint to **0** (zero) in *Fleet Manager II*.

To change the factory-defined alarm setpoints, refer to the following options in [Sensor Configuration](#).

- [Low Alarm](#)
- [High Alarm](#)
- [TWA Alarm](#)
- [STEL Alarm](#)

Bump Test

A bump test is the process of applying a small amount of test gas to force the detector into alarm. A bump test should be performed regularly to confirm the sensors are responding correctly to gas, and that the audible, visual, and vibrator alarms activate during an alarm condition. Calibrate if the readings are not within specified limits.

Bump Test Logging

If gas is manually applied to the sensors, it will be recorded as a peak event in the event logs. A bump test will be recorded in the event log as a bump if

- a [Bump Interval](#) has been defined, when prompted during startup to apply gas, it will be recorded as a bump test

Or

- the MicroDock II performs the bump test.

To view event logs, import the event logs into Fleet Manager II. Refer to the *Fleet Manager II Quick Reference Guide*.

Performing a Bump Test

⚠ Caution

BW recommends to bump test the sensors before each day's use to confirm their ability to respond to gas by exposing the sensors to a gas concentration that exceeds the alarm setpoints.

GasAlertQuattro
User Manual

To perform a manual bump test, refer to [Table 11.](#), [Figure 8.](#), [Figure 9.](#), and the following steps 1-6. Follow this procedure when Force Bump is enabled and a bump test is required during startup.

Table 11. Bump Test Installation

Item	Description
1	Gas cylinder and regulator
2	Calibration hose
3	Knob
4	Calibration cap

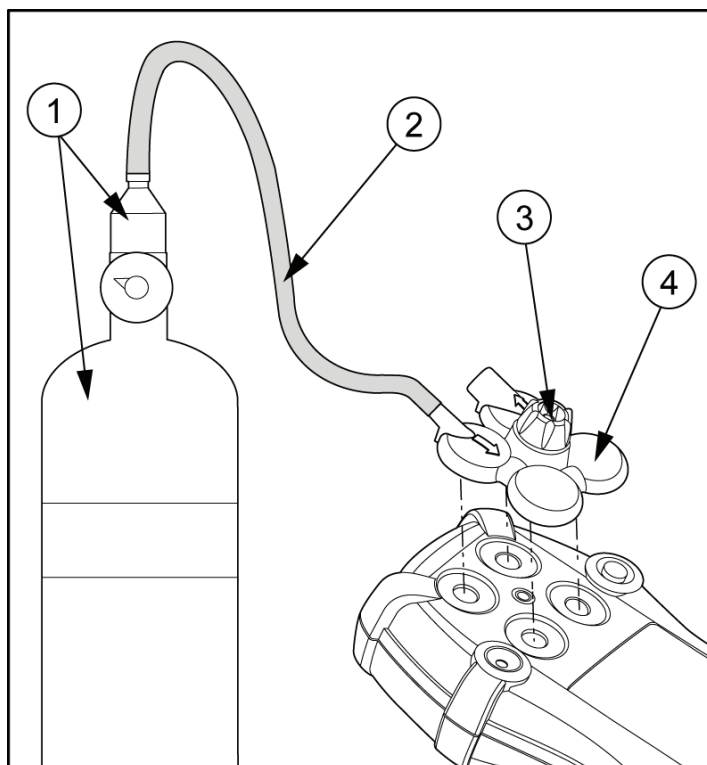

Figure 8. Bump Test Installation

1. Connect the calibration hose to the 0.5l/min regulator on the gas cylinder.

Note

Only use the calibration cap for bump tests and calibrations.

2. Connect the calibration hose to the intake inlet on the calibration cap. Arrows on the calibration cap indicate the direction of gas flow.
3. Attach the calibration cap and tighten the knob.

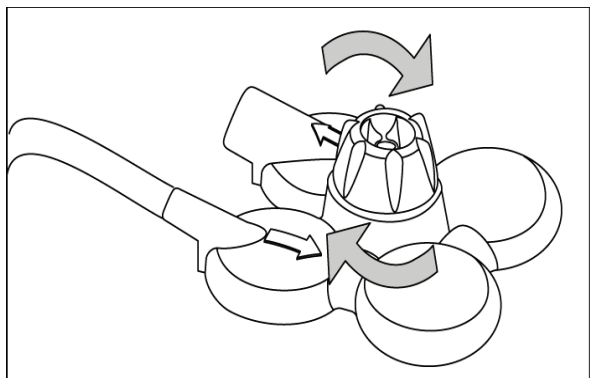

Figure 9. Tightening the Calibration Cap

Note

Ensure the knob is securely fastened before applying gas. Do not overtighten the calibration cap. Ensure strong air currents are kept away from the exhaust side of the calibration cap, as this can affect the bump test accuracy.

4. Apply gas. Verify the visual, audible, and vibrator alarms activate.
5. Close the regulator and remove the calibration cap from the detector. The detector will temporarily remain in alarm until the gas clears from the sensors.
6. Disconnect the calibration hose from the cap and regulator.

Calibration

Calibration is performed to adjust the sensitivity levels of sensors to ensure accurate responses to gas.

Guidelines

Recommended calibration quad gas mixture:

Note

Ensure balance is nitrogen (N₂)

CO: 100 ppm

H₂S: 25 ppm

LEL: 50% LEL or 2.5% by vol. methane

O₂: clean air, 18%

- To ensure accurate calibration, use a premium-grade calibration gas. Gases approved by the National Institute of Standards and Technology (NIST) ensure the accuracy of the calibration.
- Do not use a gas cylinder past its expiration date.
- Calibrate a new sensor before use. Install the sensor, activate the detector, and allow the sensor to stabilize before starting calibration or a bump test.
Used sensor: 60 seconds / new sensor: 5 minutes
- Calibrate the sensors at least once every 180 days, depending upon use and sensor exposure to poisons and contaminants.
- Calibrate only in a safe area that is free of hazardous gas in an atmosphere of 20.9% oxygen.
- If performing a single gas calibration, calibrate the O₂ sensor first.

- The H₂S, CO, LEL, and O₂ sensors can be automatically zeroed each time the detector is activated if the **Auto-Zero on Startup** option is enabled (sensors are enabled individually). Activate the detector in a normal (20.9% or 20.8% O₂) atmosphere.
- If a certified calibration is required, contact [BW Technologies by Honeywell](#).
- Manual calibration is performed using a 0.5 l/min regulator. To calibrate using the MicroDock II station, use a demand flow regulator and refer to the *MicroDock II User Manual*.
- The maximum hose length for calibration is 3 ft. (1 m).
- Do not attach the calibration cap until instructed to apply gas.

⚠ Warning

Calibration cylinders that are used with a demand flow regulator must meet the following maximum inlet pressure specifications:

- Disposable cylinders 0-1000 psig/70 bar
- Refillable cylinders 0-3000 psig/207 bar

BW recommends using premium grade calibration gases and cylinders that are certified to National Standards to ensure accurate calibration.

Connecting the Gas Cylinder to the Detector

Refer to [Figure 10.](#), [Figure 11.](#), and the following procedures to connect the gas cylinder to the detector for calibration. Read steps 1-6 before starting calibration.

1. Verify the calibration gas being used matches the span concentration value(s) that are set for the detector.
2. Attach a 0.5 l/min regulator to the gas cylinder. To calibrate with the MicroDock II station, use a demand flow regulator and refer to the *MicroDock II User Manual*.
3. Connect the calibration hose to the intake valve on the calibration cap and tighten the knob. Arrows on the calibration cap indicate the direction of gas flow.

Do not attach the calibration cap until instructed to apply gas.

Note

Ensure the knob is securely fastened before applying gas. Do not overtighten the calibration cap. Ensure strong air currents are kept away from the exhaust side of the calibration cap, as this can affect the calibration accuracy.

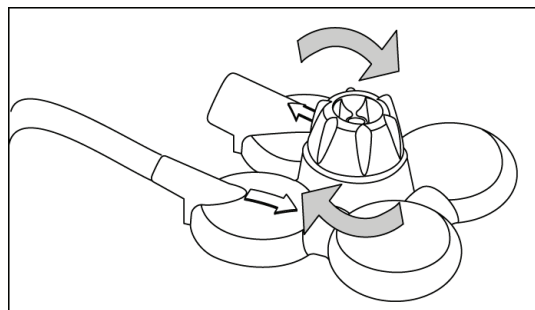

Figure 10. Calibration Cap Installation

4. Connect the calibration hose to the regulator on the gas cylinder.
5. Refer to [Calibration Procedures](#) to begin calibration.
6. When calibration is complete, disconnect the hose from the calibration cap and the regulator.



Figure 11. Connecting the Gas Cylinder to the Detector

Calibration Procedures

The calibration procedure is written as the procedure is intended. If an error or alarm screen displays, refer to [Calibration Troubleshooting](#).

Single Gas Calibration

⚠ Caution

If performing a single gas calibration, calibrate the oxygen sensor first.

Quad Gas Calibration

The following steps are written for manual calibration using a standard quad gas cylinder. For automated calibration, refer to the *MicroDock II User Manual*.

Calibration can only be aborted after the sensors have been zeroed. If is pressed to abort, **CALIBRATION cancelled** displays.

⚠ Caution

Calibrate only in a safe area that is free of hazardous gas in an atmosphere of 20.9% oxygen.

If performing single gas calibration, calibrate O₂ first.

To calibrate the sensor(s), complete the following:

1. Activate the detector.
2. In Fleet Manager II, verify the calibration gas being used matches the span concentration value(s) that are defined for the detector.

3. Press and hold  as the detector performs the Powering Off countdown.



Important!

Continue holding  until the Calibration started screen displays, otherwise the detector will deactivate.

4. Continue holding  when **OFF** displays.

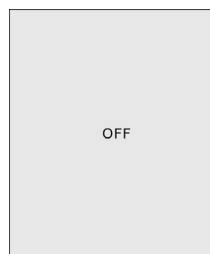

5. The detector then performs the calibration countdown. Continue holding  when the **Starting Calibration** screen displays.

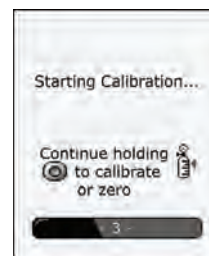

6. If **Cal IR Lock** is enabled, an IR device (IR Link or MicroDock II station) must be used to continue calibration. The following screen displays.



Connect to an IR device and refer to one of the following:

- [Calibrating Using an IR Device](#)
- *MicroDock II User Manual*

7. Release  when **Calibration Started** displays.



Zero Sensor

Note

*Do not apply calibration gas until **Apply Gas** displays, otherwise the zero function will fail.*

8. The detector enters the zero function. **zeroing** displays while the detector zeroes all the sensors.

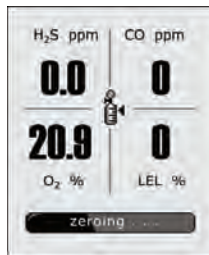

 **Caution**

A sensor that fails zero cannot be calibrated. If a sensor fails, refer to [Calibration Troubleshooting](#).

Apply Calibration Gas

9. When the following screen displays, attach the calibration cap. Refer to [Figure 12](#). If a sensor is not due yet for calibration, its box will have a greyed-out checkmark.

If zeroing sensors, press  to abort calibration to return to normal operation.

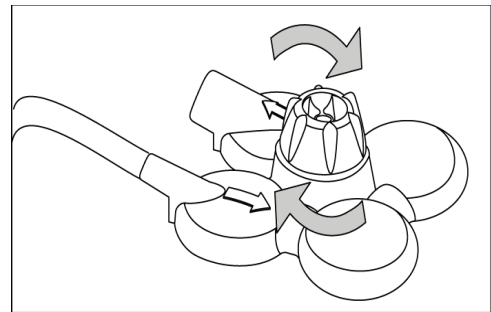
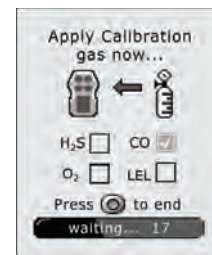



Figure 12. Attaching the Calibration Cap

Attach the calibration cap to the detector ([Figure 12.](#)). Turn the calibration cap knob firmly to ensure a tight seal to the detector.

Note

Ensure the knob is securely fastened before applying gas. Do not overtighten the calibration cap. Ensure strong air currents are kept away from the exhaust side of the calibration cap, as this can affect the calibration accuracy.

10. Open the valve on the regulator and apply gas at a flow rate of 250-500 ml/min.
11. The detector initially tests for gas. When a sufficient amount of gas is identified,  displays beside each gas that is detected.



12. The detector then begins calibrating the sensors.

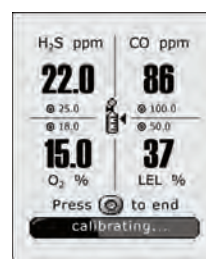

The following activities occur during the span:

- **calibrating** displays at the bottom of the screen.
 - Gas values adjust during the span.
 - Target gas values that are defined in Fleet Manager II display above or below the adjusting gas value.
13. When the following screen displays, close the valve on the gas cylinder and remove the calibration cap from the detector. A checkmark displays beside each sensor that has calibrated successfully.

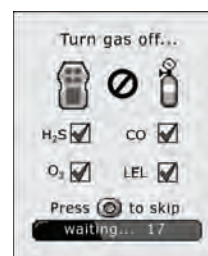

14. When calibration is complete, the following screen displays.



Note

If a sensor fails calibration or an error screen displays, refer to [Calibration Troubleshooting](#).

Days to Next Calibration

Note

If a sensor fails calibration, the next calibration due date for that sensor will not reset. Refer to [Calibration Troubleshooting](#).

15. All successfully calibrated sensors automatically reset to the number of days defined in the **Cal Interval** field in Fleet Manager II.

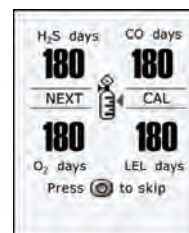

The detector now enters normal operation.

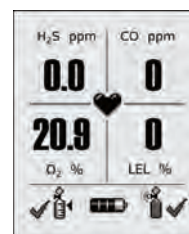

Calibrating Using an IR Device

If the **Cal IR Lock** option is enabled, the sensors must be calibrated using one of the following IR devices:

- [IR Link With Fleet Manager II](#)
- MicroDock II Station (refer to the *MicroDock II User Manual*)

IR Link With Fleet Manager II

To calibrate using the IR Link with Fleet Manager II, complete the following:

1. From the PC, open Fleet Manager II.

2. Click **Administration**.

3. From the Administration toolbar, click  to access the Enter Password dialog box.

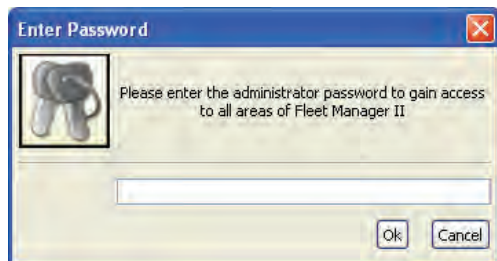



Figure 13. Enter Password Dialog Box

4. Enter **Admin** and click **OK** (password is case sensitive).

5. From the Devices toolbar, click . The Device Selection popup displays.

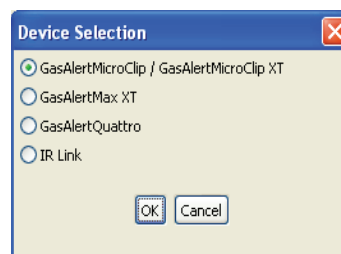

Figure 14. Device Selection Popup

6. Select **GasAlertQuattro**.

7. Activate the detector and wait for the startup self-tests to complete.

Calibration can be performed during the startup sequence if

- **Calibration overdue** displays,
- **Calibration IR lock enabled** displays,
- or when the detector in normal operation.

8. From Fleet Manager II, click  located at the bottom of the window.

The **Calibrate Device** dialog box displays.

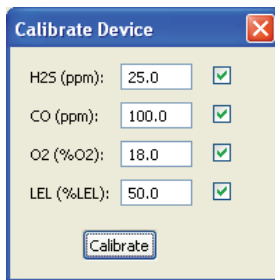

Figure 15. Calibrate Device Dialog Box

9. Enter the span gas concentration values. The values entered in the Calibrate Device popup must match the span concentration values on the gas cylinder, otherwise calibration will fail.

10. Click inside the checkbox for each sensor that will be calibrated, and then click **Calibrate**. The following screen displays.



11. Return to [Zero Sensor](#) step #8 in the [Calibration Procedures](#) to continue calibration.

Event Logs

The detector records the 30 most recent gas alarm events. Information that is recorded from an event is as follows:

- Peak alarm levels during an alarm
- Start time and date of alarm
- Type of exposure, level, and duration of alarm
- Records and stores the last thirty events (excluding bump tests)
- Records and stores the last 10 bump test events for each sensor
- Records and logs when low alarms are acknowledged

When 30 event logs have been recorded, the next event log overwrites the oldest event log.

Datalogs

The detector records datalog samples that can be compiled to create a report using Fleet Manager II. From Fleet Manager II, define how often the detector records a datalog sample (1-120 seconds) in the **Datalog Interval (seconds)** field.

The total number of 8-hour days datalog samples that can be recorded is assuming 90% of the day has no gas concentrations.

Table 12. Datalog Frequency

Datalog Interval	Total Number of 8-Hour Days Datalogs Can Be Recorded
5 seconds	15 days
15 seconds	45 days
60 seconds	180 days

When the memory is full, the detector replaces the oldest datalog samples with the most recent datalog samples.

The following information is recorded in a datalog:

- Alarms
- Date and time
- Sensor readings and sensor status
- Serial number
- Detector status
- TWA and STEL readings
- Times the detector was activated and deactivated

- Battery status
- Configuration changes
- Low and high alarm setpoints (all sensors)
- STEL and TWA alarm setpoints (H₂S and CO only)
- STEL and TWA interval settings (H₂S and CO only)
- Fleet Manager II options that are defined for the detector and configuration changes
- Low alarm acknowledges
- Cal due and bump due disregarded via button press
- Calibration and bump test interval settings
- Calibration data: zero, span, time, date, and pass/fail events
- Bump test (time, date, and pass/fail events)
- Battery status
- Log type
- Temperature
- Datalog interval
- Language
- Sensor options

Bump and Calibration Results

The detector records the MicroDock II bump test and calibration results. The results can then be imported into Fleet Manager II to create detailed reports.

Note

To record calibration and bump test results, the detector must be calibrated and bump tested using the MicroDock II station.

The following information is recorded in the calibration and bump test results:

- Date/time bump tests and calibrations are performed
- Serial number
- Test performed
- Test results
- Detector status
- Detector configuration updates during bump test/calibration
- Type of detector
- MicroDock II serial number
- Last calibration performed
- Next calibration due date

- Last bump test performed
- Next bump test due date
- Datalog interval
- STEL period
- Audible and visual indicator status
- Sensor type and sensor status
- Alarm status
- Sensor status
- MicroDock II inlet(s) used

Downloading Datalogs and Event Logs

The datalog and event log files can only be downloaded to a PC using the IR Link or the MicroDock II base station. Refer to one of the following:

- *Fleet Manager II Quick Reference Guide*
- *MicroDock II User Manual*

When downloading event logs and datalog from the detector with the IR Link, the following screens displays. An icon displays between the battery icon and bump test icon.

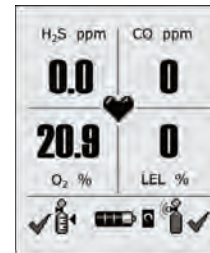

Software Requirements

- Windows XP or Windows Vista operating system (required)
- Fleet Manager II (required)
- Microsoft Excel (optional)

Reports are generated using Fleet Manager II where filters can be defined, or data can be exported to Microsoft Excel for custom reports.

For more information, refer to the *Fleet Manager II Quick Reference Guide*.

Maintenance

To maintain the detector in good operating condition, perform the following basic maintenance as required.

- Calibrate, bump test, and inspect the detector at regular intervals.
- Maintain an operations log of all maintenance, bump tests, calibrations, and alarm events.
- Clean the exterior with a soft damp cloth. Do not use solvents, soaps, or polishes. Refer to [Sensor Poisons and Contaminants](#).

Battery Charging and Maintenance Cautions

⚠ Warning

To avoid personal injury and/or property damage, adhere to the following:

- Charge the battery immediately when the detector emits a low battery alarm. Refer to [Charging the Rechargeable Battery](#).
- Use only BW recommended alkaline batteries. Refer to [Specifications](#).
- Charge the battery in a safe area that is free of hazardous gas in temperatures ranging from of 32°F to 104°F (0°C to 40°C).

- Charge the battery using BW charger adapters designed for the GasAlertQuattro only. Do not use any other charger adapters. Failure to adhere to this caution can lead to fire and/or explosion.
- The charging adapter is voltage specific to your region. Use of the charging adapter outside your region will damage the charger and the detector.
- **Warning:** The GasAlertQuattro uses a lithium battery (QT-BAT-R01) that may present a risk of fire or chemical burn hazard if misused. Do not disassemble, heat above 212° (100°C), or incinerate.
- **Warning:** Lithium polymer cells exposed to heat at 266°F (130°C) for 10 minutes can cause fire and/or explosion.
- If replacing the battery, use only approved lithium polymer cells that are available through BW Technologies by Honeywell. Use of any other cell can cause fire and/or explosion. To order and replace the QT-BAT-R01 lithium battery pack, refer to [Replacement Parts and Accessories](#).
-  Dispose of used lithium cells immediately. Do not disassemble and do not dispose of in fire. Do not mix with the solid waste stream. Spent batteries must be disposed of by a qualified recycler or hazardous materials handler.
- Keep lithium cells away from children.

Charging the Rechargeable Battery

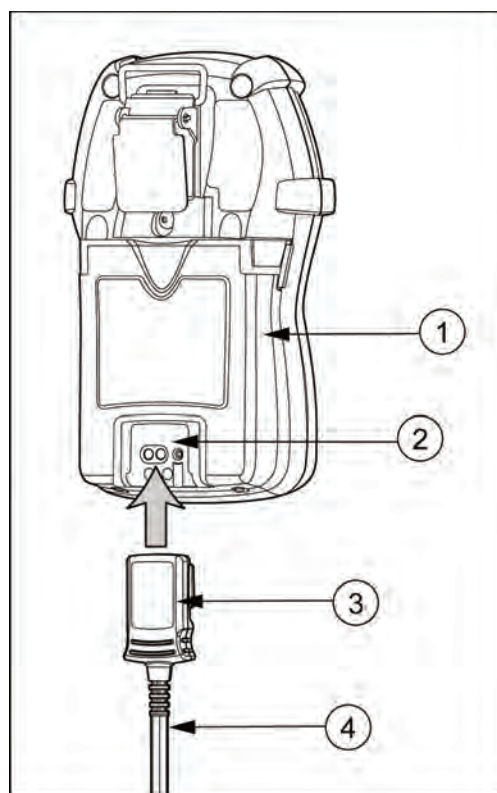

Figure 16. Connecting the Charger Adapter

Table 13. Connecting the Charger Adapter

Item	Description
1	Detector
2	IR and charger interface
3	Charger adapter
4	Charger cable

⚠ Warning

The battery must be charged in a safe area that is free of hazardous gas in temperatures of 32°F to 104°F (0°C to 40°C).

To charge the battery, refer to [Figure 16.](#), [Table 13.](#) and the following procedures:

1. Press and hold ○ to deactivate the detector.

Note

The time required to charge will increase if the detector is activated.

2. Plug the charger into a AC outlet.

⚠ Caution

The charging adapter is voltage specific to your region. Use of the charging adapter outside your region will damage the charger and the detector.

3. Attach the charging adapter to the charger interface.

4. The lithium battery may require 6 hours to reach full capacity.

While charging, the LCD displays the battery icon.

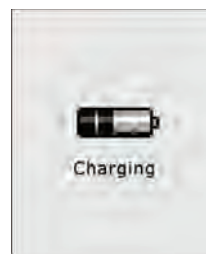

When the battery is fully charged, the following screen displays.



5. If a problem occurs, refer to [Troubleshooting.](#)

Note

The detector may be warm during charging. This is normal. To preserve the life of the battery, deactivate the detector when not in use.

Optimum Battery Operation

To ensure maximum use of the battery, perform the following:

- To obtain full operating capacity, allow the battery to fully charge and discharge three times.
- To achieve the maximum number of charges, ensure the battery is charged between 32°F and 104°F (0°C and 40°C). Do not charge the battery in temperatures above 113°F (45°C).

Rechargeable Battery Capacity

A rechargeable battery's runtime decreases approximately 20% over a two-year period of typical use.

Replacing the Battery Pack

Battery Pack Retaining Screw

The retaining screw provided with the detector must be used to lock the battery pack on all European and IECEx scheme detectors, and on all Canadian and US Zone certified detectors.

The screwdriver included with the detector has a double-ended driver. Loosen the brass nut to switch between a Phillips head and a hex head.

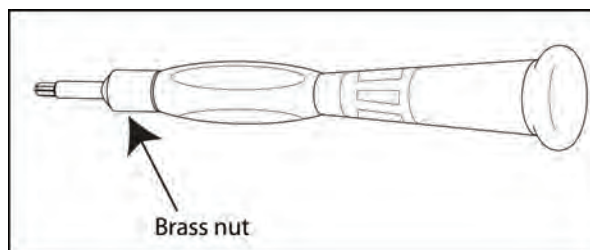

Figure 17. Screwdriver

A hex tool is required to tighten and loosen the retaining screw. Tighten the screw 1-2 turns using 3-4 in-lbs of torque. Do not overtighten the screw.

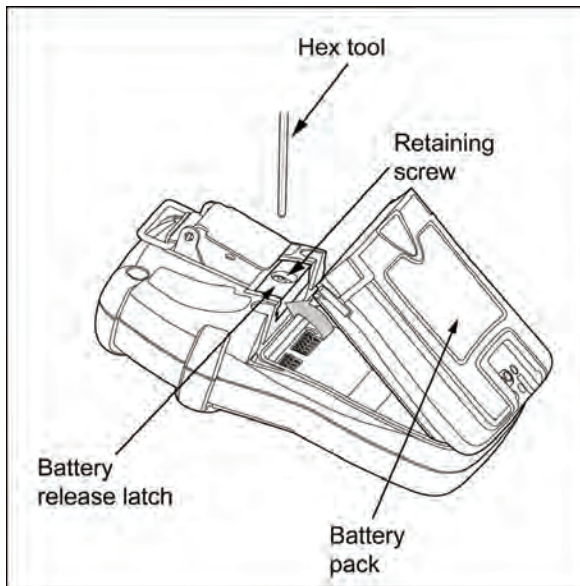



Figure 18. Removing the Battery Pack

1. Press and hold  to deactivate the detector.
 2. If using the retaining screw, loosen it 1-2 turns. Push the battery release latch toward the top of the detector to release the battery pack.
 3. From the top of the battery pack, lift the battery pack upward to remove.
 4. Insert the new battery pack. Insert the bottom of the battery pack first at a 30° angle, then lower the top into place. Press until the release tab engages.
- If using the retaining screw, tighten it 1-2 turns using 3-4 in-lbs of torque.

Replacing the Alkaline Batteries

⚠ Warning

To avoid personal injury and/or damage to the detector, use only BW recommended alkaline batteries. Refer to [Specifications](#).

Change the alkaline batteries only in safe area that is free of hazardous gas.

To replace the alkaline batteries, refer to [Figure 19.](#), [Figure 20.](#), [Figure 21.](#), and [Figure 22.](#), and steps 1-6.

1. Press and hold  to deactivate the detector.
2. If using the retaining screw, loosen it 1-2 turns. Push the battery release latch toward the top of the detector to release the battery pack.

3. Remove the alkaline battery pack. Refer to [Replacing the Battery Pack](#).
4. Unhook the ejector bar from the release clasp. Move the ejector bar towards the top of the battery pack until it is aligned horizontally over the batteries.

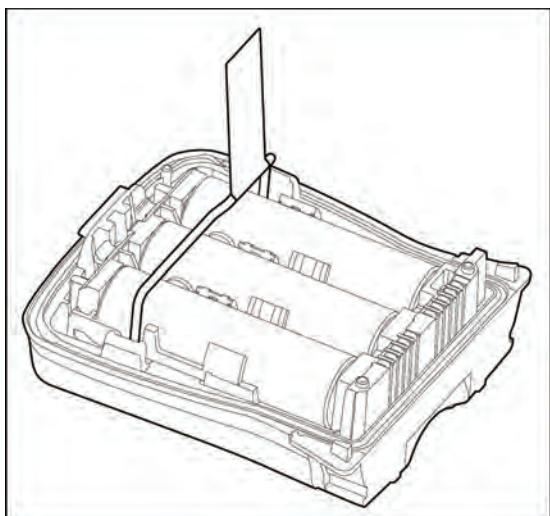

Figure 19. Ejector Bar Unhooked from Release Clasp

5. Using the tab, pull on the ejector bar.

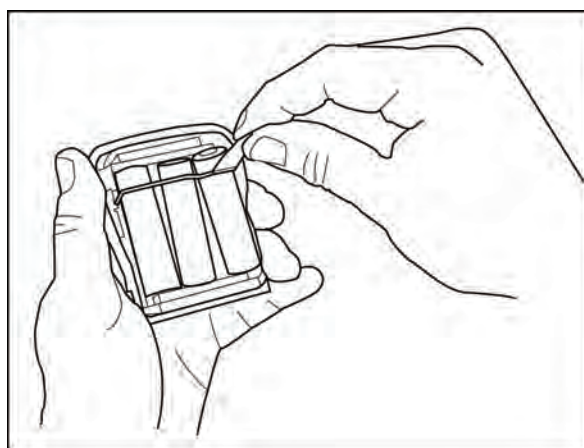

Figure 20. Using the Tab to Pull on the Ejector Bar

6. To the left of the tab, pull up on the ejector bar.

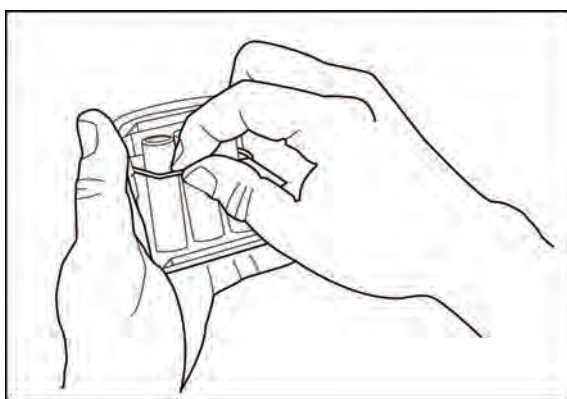

Figure 21. Pulling up on the Ejector Bar

7. Remove the spent batteries.
8. Reset the ejector bar to its original flat position. Ensure the ejector bar engages the release clasp.

9. Insert the new batteries. Position the positive end of the battery at a 30° angle and insert into the battery pack before pushing the negative end down into place. Refer to [Figure 22](#).

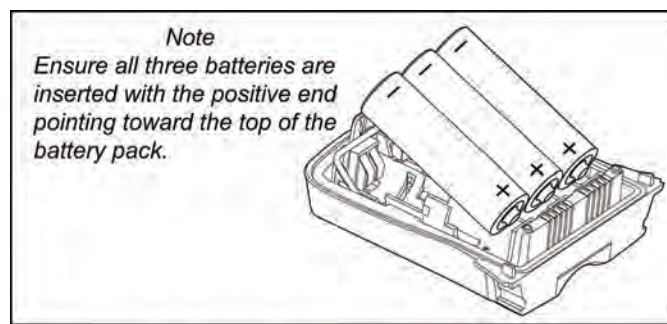

Figure 22. Inserting the Alkaline Batteries

10. Replace the battery pack by inserting the bottom first, then lower the top into place. Ensure the tab is tucked in before replacing the battery pack.
11. Press until the release tab clicks. If required, tighten the retaining screw using 3-4 in. lbs torque.

Replacing the Sensors

⚠ Warning

To avoid personal injury and/or property damage, use only sensors that are specifically designed for the detector. Refer to [Replacement Parts and Accessories](#).

⚠ Caution

Each sensor has a high degree of resistance to common vapors and gases. To clear a sensor, move the detector to a clean environment and wait 10 to 30 minutes.

To prevent accidental poisoning of sensors, refer to [Table 3. Sensor Poisons and Contaminants](#).

To replace a sensor or sensor filter, refer to the following steps 1-10 and [Figure 23](#).

Note

Detectors that are configured for 1, 2, or 3 gases, may contain a dummy sensor in one of the four sensor locations.

1. Press and hold ○ to deactivate the detector.
2. Press the release latch and remove the battery pack.
3. Remove the six machine screws from the rear shell.
4. Remove the front shell.
5. Remove the spent sensor(s). Use caution when removing the sensor(s) to ensure no damage occurs to the LCD.
6. Insert the new sensor(s).
7. Reassemble the detector. Press the front and rear shells together firmly to ensure a proper seal. Ensure the front and rear shells have a tight, uniform 1/16 in. (1 mm) seal on all sides of the detector.
8. Replace the six machine screws using 3-4 in. lbs of torque. Do not overtighten the screws.
9. Replace the battery pack.
10. New sensors should be calibrated prior to use. Calibrate the new sensor(s) immediately. Refer to [Calibration](#).

Note

When a new sensor has been inserted, the detector may enter alarm when the detector is activated.

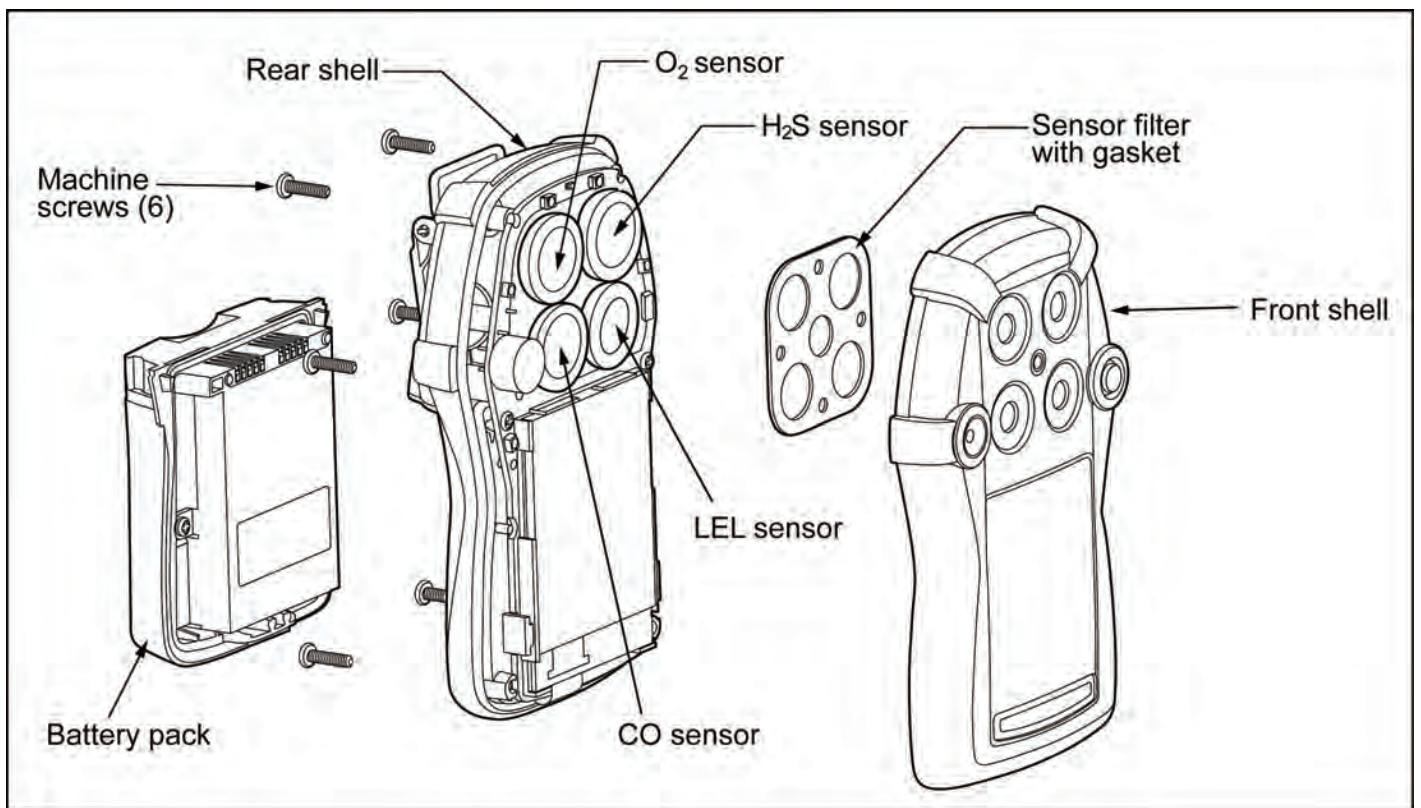

Figure 23. Replacing a Sensor or Sensor Filter

Replacing the Sensor Filter

To replace the sensor filter, refer to [Figure 24.](#), [Figure 25.](#) and the following steps 1-9.

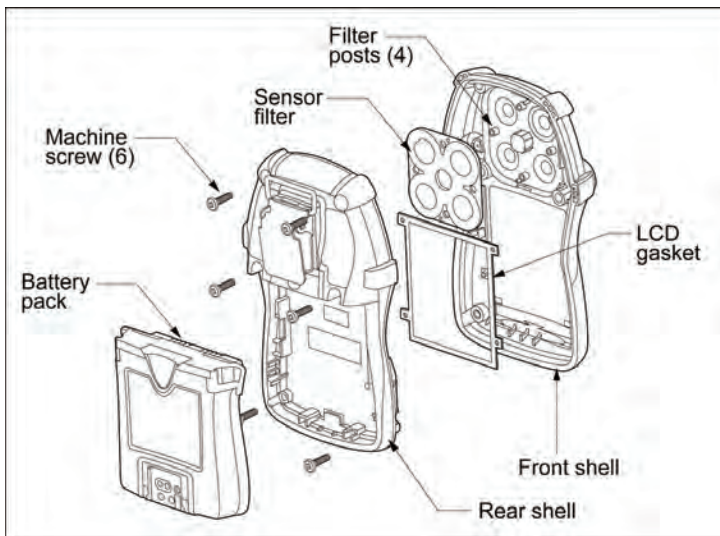



Figure 24. Replacing the Sensor Filter

1. Press and hold  to deactivate the detector.
2. Press the release latch and remove the battery pack. Refer to [Replacing the Battery Pack.](#)

3. Remove the six machine screws from the rear shell.
4. Remove the front shell.
5. Remove the sensor filter.
6. Refer to [Figure 25.](#) before inserting the new filter. Ensure the filter is laying flat and that the holes are correctly aligned over the filter posts.

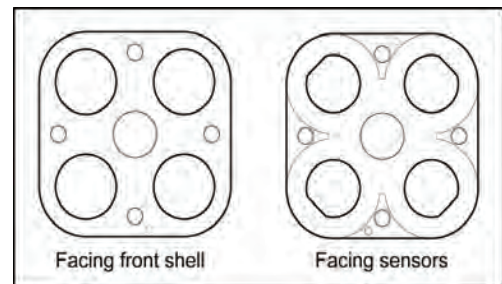

Figure 25. Inserting the Sensor Filter Correctly

7. Replace the front shell. Press the front and rear shells together firmly to ensure a proper seal. Ensure the front and rear shells have a tight, uniform 1/16 in. (1 mm) seal on all sides of the detector.
8. Replace the six machine screws using 3-4 in. lbs torque. Do not overtighten the screws.
9. Replace the battery pack.

Troubleshooting

If a problem occurs, refer to the solutions provided in [Table 14](#). Also refer to [Startup Troubleshooting](#), [Calibration Troubleshooting](#), and [Bump Test Troubleshooting](#). If the problem persists, contact [BW Technologies by Honeywell](#).

Table 14. Troubleshooting

Problem	Possible Cause	Solution
Startup		
The detector does not activate.	Depleted battery.	Replace alkaline batteries. Refer to Replacing the Alkaline Batteries .
		Charge the rechargeable battery pack. Refer to Charging the Rechargeable Battery .
	Damaged detector.	Contact BW Technologies by Honeywell.
Detector automatically deactivates.	Automatic deactivation due to critical low battery.	Replace alkaline batteries. Refer to Replacing the Alkaline Batteries .
		Charge the rechargeable battery pack. Refer to Charging the Rechargeable Battery .
	Lockout on Self-Test Error is enabled and a sensor(s) has failed the startup self-test.	Refer to Lockout on Self-Test Error and Replacing the Sensors.
	Sensor(s) requires calibration.	Refer to Calibration Procedures.

Table 14. Troubleshooting

Problem	Possible Cause	Solution
The detector enters alarm immediately when activated.	Sensor needs to stabilize.	Used sensor: Wait 60 seconds New sensor: Wait 5 minutes
	Low battery or critical low battery alarm.	Replace alkaline batteries. Refer to Replacing the Alkaline Batteries .
		Charge the rechargeable battery pack. Refer to Charging the Rechargeable Battery .
	Hazardous environment.	Leave the area immediately. Deactivate and reactivate the detector in a safe area that is free of hazardous gas, in an atmosphere of 20.9% oxygen.
	A new sensor has been inserted	Calibrate the sensor.
The activation startup self-test fails.	General fault.	Contact BW Technologies by Honeywell .
	Sensor error.	Refer to Startup Troubleshooting. If required, refer to Replacing the Sensors.

Table 14. Troubleshooting

Problem	Possible Cause	Solution
Detector Operation		
Detector does not display normal gas reading after startup sequence.	Sensors not stabilized.	Used sensor: Wait 60 seconds New sensor: Wait 5 minutes
	Sensor(s) requires calibration.	Refer to Calibration Procedures .
	Target gas is present.	Detector is operating properly. Use caution in suspect areas.
Detector does not respond to push-button.	Battery is in critical low battery state or is completely depleted.	Replace alkaline batteries. Refer to Replacing the Alkaline Batteries . Charge the rechargeable battery pack. Refer to Charging the Rechargeable Battery .
	Detector is performing operations that do not require user input.	Button operation restores automatically when the operation ends.
Detector does not accurately measure gas.	Sensor(s) requires calibration.	Refer to Calibration Procedures .
	Detector is colder/hotter than gas temperature.	Allow the detector to attain ambient temperature before use.
	Sensor filter is blocked.	Refer to Replacing the Sensor Filter .

Table 14. Troubleshooting

Problem	Possible Cause	Solution
Detector does not enter alarm.	Alarm setpoint(s) are set incorrectly.	Refer to Sample Gas Alarm Setpoints . Define the alarm setpoints in Fleet Manager II.
	Alarm setpoint(s) set to zero.	Refer to Sample Gas Alarm Setpoints . Define the alarm setpoints in Fleet Manager II.
	Detector is in calibration mode.	Complete the calibration procedure.
Detector intermittently enters alarm without reason.	Ambient gas levels are near alarm setpoint or the sensor is exposed to a puff of the target gas.	Detector is operating normally. Use caution in suspect areas. Check peak gas exposure reading.
	Alarm setpoints are set incorrectly.	Refer to Sample Gas Alarm Setpoints . Define the alarm setpoints in Fleet Manager II.
	Sensor(s) requires calibration.	Refer to Calibration Procedures .
	Missing or faulty sensor(s).	Refer to Replacing the Sensors .
Features and options are not operating as expected.	Changes in Fleet Manager II.	Verify that the settings in Fleet Manager II are correct.

Table 14. Troubleshooting

Problem	Possible Cause	Solution
Charging		
Battery has been charging for 6 hours. Charging indicator on LCD shows the battery is still charging.	Battery is trickle charging.	Battery is fully charged and is ready for operation.
Battery indicator does not display when charging.	Battery is depleted below normal levels	Charge the battery for 8 hours. If the battery indicator does not light after charging, contact BW Technologies by Honeywell .

Startup Troubleshooting

Table 15. Startup Troubleshooting











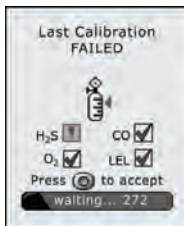

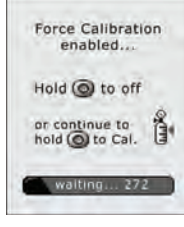

Error Screen	Problem	Solution	Error Screen	Problem	Solution
	Auto-zero Error Sensor(s) failed to auto-zero	Calibrate the sensor.		Last Calibration Failed Displays when the last calibration failed. If the Force Calibration option is enabled, the sensors must be calibrated.	Press  and calibrate the sensor(s) immediately. Refer to Calibration Procedures . If Cal IR Lock is enabled, an IR device (IR Link or Micro-Dock II) must be used to calibrate.
	Self-test Failed Sensor(s) fails the self-test during startup.	Press  to accept the failed sensor(s). The Sensor self test error accepted screen displays. Replace the sensor when startup is complete. Refer to Replacing the Sensors .		Force Calibration If the Force Calibration option is enabled, the sensors must be calibrated to enter normal operation.	Press and hold  to calibrate the sensors, or press  and release to deactivate the detector. Refer to Calibration Procedures . If Cal IR Lock is enabled, an IR device (IR Link or Micro-Dock II) must be used to calibrate.
	All Sensors Fail If the Lockout on Self-test Error option is enabled and all sensors fail, the detector automatically deactivates.	A failure of all sensors can be caused by poisoning (alcohol and silicon). Allow sensors to recover for 1 hour. If sensors fail startup again, refer to Replacing the Sensors .		Calibration Overdue Displays when calibration is past due. If the Force Calibration option is enabled, the sensor(s) must be calibrated to enter normal operation.	Press  to continue and calibrate the sensor(s) immediately. Refer to Calibration Procedures . If Cal IR Lock is enabled, an IR device (IR Link or Micro-Dock II) must be used to calibrate.

Table 15. Startup Troubleshooting

Error Screen	Problem	Solution	Error Screen	Problem	Solution
	<p>Last Bump Test Failed If the last bump test failed and the Force Bump Test option is enabled, a bump test must be performed.</p>	<p>Use the MicroDock II station to perform a bump test, otherwise press ○ to deactivate the detector. If you do not have a MicroDock II, change the bump interval in Fleet Manager II to Refer to Bump Test.</p>		<p>Bump Test Overdue Screen displays when sensors are overdue for a bump test and the Force Bump test option is disabled.</p>	<p>Apply gas directly or use the MicroDock II, otherwise press ○ to enter normal operation with the bump test overdue. Refer to Bump Test.</p>
	<p>Force Bump Test If the Force Bump Test option is enabled, the sensors must be bump tested to enter normal operation.</p>	<p>Apply gas immediately or use the MicroDock II station, otherwise press ○ to deactivate the detector. Refer to Bump Test.</p>	<p>⚠ Caution BW Technologies by Honeywell recommends to bump test the sensors before each day's use to confirm their ability to respond to gas by exposing the detector to a gas concentration that exceeds the alarm setpoints.</p>		

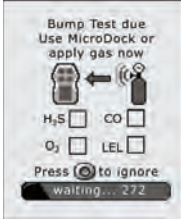
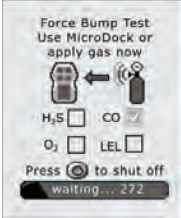
Calibration Troubleshooting

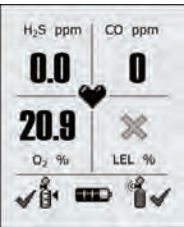
Table 16. Calibration Troubleshooting

Error Screen	Problem	Solution	Error Screen	Problem	Solution
	Detector deactivates while trying to calibrate Detector does not enter calibration. Displays OFF and then deactivates.	Activate the detector. When in normal operation, initiate calibration. Press and continue holding ○ (through a series of screens) until Calibration started displays.		Cal IR Lock Enabled IR lock enabled screen displays.	An IR device must be used to calibrate (IR LInk or Micro-Dock II station). For manual calibration, refer to Calibrating Using an IR Device . For automated calibration, refer to the <i>Micro-Dock II User Manual</i> .
	Self-test Fail If a sensor(s) fails auto zero, an error message displays showing which sensor(s) failed.	Replace the sensor or contact BW Technologies by Honeywell . Refer to Replacing the Sensors .		Calibration Error Insufficient amount of gas detected.	Verify the span gas values on the cylinder match the span gas values set for the detector. Ensure gas is applied at a flow rate of 250-500 ml/min. Ensure cylinder is not empty or past expiry. Replace immediately if required. Replace the regulator if required.

Bump Test Troubleshooting

For bump test troubleshooting recommendations, refer to Table 15.

Replacement Parts and Accessories

⚠ Warning

To avoid personal injury or damage to the detector, use only the specified replacement parts.

To order parts or accessories listed in the following table, contact [BW Technologies by Honeywell](#).

Table 17. Replacement Parts and Accessories

Model No.	Description	Qty
Sensors		
SR-W04-75C	Combustible (LEL) sensor	1
SR-X10-C1	Oxygen (O ₂) sensor	1
SR-M04-SC	Carbon monoxide (CO) sensor	1
SR-H04-SC	Hydrogen sulfide (H ₂ S) sensor	1
Sensor Filters		
QT-SS	Sensor filters (kit of 2)	1
QT-SS-K1	Sensor filters (kit of 10)	1
Regulators		
REG-DF-1	Demand flow regulator	1
REG-0.5	0.5 l/min regulator	1

Model No.	Description	Qty
Gas Cylinders and Kits		
CG-Q58-4	Quad gas cylinder: CH ₄ -2.5%, O ₂ -18.0%, H ₂ S-25 ppm, CO-100 ppm, bal. N ₂ (58 l)	1
CG-Q34-4	Quad gas cylinder: CH ₄ -2.5%, O ₂ -18.0%, H ₂ S-25 ppm, CO-100 ppm, bal. N ₂ (34 l)	1
CG-T34	Dual gas cylinder: 50% LEL (CH ₄ -2.5%) O ₂ -20.9%, bal. N ₂ (34 l)	1
G0042-H25	Single gas cylinder: H ₂ S 25 ppm, bal. N ₂ (58 l)	1
CG2-M-200-103	Single gas cylinder: CO 200 ppm, bal N ₂ (103 l)	1
CG-BUMP1	Bump alarm gas aerosol (CH ₄ -2.5%, O ₂ -10%, H ₂ S-40 ppm, CO-200 ppm)	1
CK-Q34-4	Quad calibration kit with regulator, quad gas cylinder (CG-Q34-4), hose, and carrying case	1
CK-Q58-4	Quad calibration kit with regulator, quad gas cylinder (CG-Q58-4), hose, and carrying case	1
QT-TC-1	Calibration cap	1
Battery Packs		
QT-BAT-R01	Rechargeable lithium battery pack	1
QT-BAT-A01	Alkaline battery pack (batteries included)	1

GasAlertQuattro
Replacement Parts and Accessories

Model No.	Description	Qty
Chargers and Power Options		
GA-PA-1-MC5	GasAlertQuattro multi-unit power adapter	1
QT-C01-MC5	GasAlertQuattro multi-unit cradle charger	1
GA-VPA-1	Vehicle power adapter	1
GA-PA-1	Replacement power adapter	1
IR Devices		
GA-USB1-IR	GasAlertQuattro IR connectivity kit	1
DOCK2-2-1 C1N-00-N	GasAlertQuattro docking module and	1
MicroDock II station (w/ charging cable)		
DOCK2-0- 1C1N-00-N	GasAlertQuattro docking module w/ charging cable	1
Accessories		
GA-BQT	Concussion proof boot	1
GA -HQT	Carrying holster	1
QT-AF-K1	Auxiliary Filter w/ LCD protector (w/ 1 filter)	1
QT-SS-AF-K1	Replacement auxiliary filters (kit of 5 filters)	1
QT-VMB-1	Vehicle mount attachment	1
XT-AG-1	Alligator clip (stainless steel)	1
GA-NS-1	Neck strap w/ safety release	1

Model No.	Description	Qty
GA-LY-1	Short strap 6 in. (15.2 cm)	1
GA-ES-1	Extension strap 4 ft. (1.2 m)	1
GA-ARM-1	Arm band	1
GA-CH-2	Chest harness	1
SPAK-CC1	Hard sided carrying case for GasAlertQuattro and/or motorized Sampling Pump	1
Replacement Parts		
QT-SCREW-K1	Replacement screw kit (40 screws and screwdriver)	1

*Add one of the following applicable suffixes to the end of the order number to ensure power adapter is correct for region.

(-UK) for United Kingdom

(-EU) for Europe

(-AU) for Australia/China

Specifications

Instrument dimensions: 13 x 8.1 x 4.7 cm (5.1 x 3.2 x 1.9 in.)

Weight:

316 g / 11.15 oz. (with rechargeable battery pack)

338 g / 11.92 oz. (with alkaline battery pack)

Operating temperature: -20°C to +50°C (-4°F to +122°F)

Storage temperature: -40°C to +60°C (-40°F to +140°F)

Operating humidity: 10% to 100% relative humidity (non-condensing)

Dust and moisture ingress: IP66/67 (with screw engaged)

Alarm setpoints: May vary by region and are user-defined

Detection range:

H₂S: 0 – 200 ppm (0.1 ppm increments from 0.0 to 39.9ppm / 1 ppm increments about 40 ppm)

CO: 0 – 1000 ppm (1 ppm increments)

O₂: 0 – 30.0% vol. (0.1% vol. increments)

LEL (combustible): 0 – 100% LEL (1% LEL increments) or 0 – 5.0% v/v methane

Sensor type:

H₂S, CO, O₂: Single plug-in electrochemical cell

Combustibles (LEL): Plug-in catalytic bead

O₂ measuring principle: Capillary controlled concentration sensor

Bump test specified limits: BW recommends using a gas cylinder that will ensure the combustible sensor has an accuracy of -0 to +20% of actual reading (reference CAN/CSA C22.2 No. 152).

Alarm conditions: TWA alarm, STEL alarm, low alarm, high alarm, multi-gas alarm, over limit (OL) alarm, low battery alarm, critical low battery alarm, IntelliFlash, confidence/compliance beep, sensor self-test failure alarm

Audible alarm: 95 dB+ at 30 cm (12 in.) variable pulsed beeper

Visual alarm: Red light-emitting diodes (LEDs)

IntelliFlash: Green light-emitting diode. Flash frequency is user-defined with the IntelliFlash interval option

Confidence/compliance beep: Audible beep from variable pulsed beeper. Beep frequency is dependent upon frequency defined for confidence/compliance beep interval option

Display: Alphanumeric liquid crystal display (LCD) with flip display (0° or 180°) capability (user-defined in Fleet Manager II)

Backlight: Activates upon startup and deactivates when self-test is complete. Activates when the pushbutton is pressed and deactivates after 10 seconds. Activates during an alarm condition and remains lit until alarm ceases

Internal vibrator: Vibrates during activation, deactivation, and all alarms

Self-test: Initiated during activation, self-test runs continuously on the battery and electrochemical sensors (H₂S and CO) while detector is operational

Calibration: Zero and automatic span

User options: Startup message, lockout on sensor error, safe mode, IntelliFlash, confidence/compliance beep, latching alarms, force calibration, force bump, calibration IR lock, flip display, stealth mode, datalog interval, IntelliFlash interval, confidence/compliance beep interval, language selection.

Sensor options: Sensor enable/disable, calibration gas values, calibration interval, bump test interval, alarm setpoints (low/high/TWA/STEL), STEL interval, TWA period, TWA method, auto zero during startup enable/disable, LEL correction factor, 10% (of reading) over-span, low alarm acknowledge, O₂ measurement, LEL gas measurement, and % vol methane measurement

Year of manufacture: The detector's year of manufacture is determined from the serial number. The second and third number after the first two letters determines the year of manufacture.

Example: QA1**09**-001000 = 2009 year of manufacture

Approved lithium battery for GasAlertQuattro product: Lithium-ion polymer (QT-BAT-R01) as per standards UL913, EN60079-11, EN60079-0, C22.2 No. 157

Rechargeable battery (QT-BAT-R01)	Temperature Code
Lithium Polymer	-20°C ≤ Ta ≤ +50°C
	T4

Lithium battery operating time: One rechargeable lithium polymer battery at 20°C provides the following operating runtimes:

20 hours at 20°C (68°F)

18 hours at -20°C (-4°F)

Approved alkaline battery pack for GasAlertQuattro (QT-BAT-A01): as per standards UL913, EN60079-11, EN60079-0, IEC 60079-0, IEC 60079-11, C22.2 No. 157

Duracell MN 1500	-20°C ≤ Ta ≤ +50°C	T4 (129.9°C)
Energizer E91 VP	20°C ≤ Ta ≤ +50°C	T3C (135.3°C)

AA alkaline battery operating time: 14 hours at 20°C (68°F)

Battery charger: charging adapter

First-time charge: 6 hours

Normal charge: 6 hours

Warranty: 2 years including sensors

Approvals:

Approved by CSA to both U.S. and Canadian Standards

CAN/CSA C22.2 No. 157 and C22.2 152

ANS/UL – 913 and ANSI/ISA – S12.13 Part 1

CSA Class 1, Division 1, Group A, B, C, D

ATEX CE 0539 Ex II 1 G Ex da ia IIC Ga for Zone 0 Group IIC

KEMA 09 ATEX 0137

EN60079-0, EN60079-11, EN60079-1

IECEX Ex da ia IIC Ga IECEX CSA 09.0006

IEC 60079-0, IEC 60079-11, IEC 60079-1

BAM BAM 11 ATEX 1102 X EN 60079-29-1 (for 0 up to 100% LEL Methane)

BAM/ZBF/005/15 EN 50104

(for 0 up to 25% v/v oxygen)

BAM EN 50271:2010 (without Clause 4.8, SIL 1 assessment)

BAM/ZBF/010/12 EN 45544

KTL 12-KB4BO-0049^a

Inmetro Ex da ia IIC Ga DNV 12.0133

a. http://www.honeywellanalytics.com/~media/honeywell-analytics/products/gasalertquattro/documents/certificates/koreanexcertificate_bw_gaquattro_12kb4bo0049.pdf?la=en

GasAlertQuattro *User Manual*

This equipment has been tested and found to comply with the limits for a Class B digital device, pursuant to Part 15 of the FCC Rules and ICES-003 Canadian EMI requirements. These limits are designed to provide reasonable protection against harmful interference in a residential installation. This equipment generates, uses and can radiate radio frequency energy and, if not installed and used in accordance with the instructions, may cause harmful interference to radio communications. However, there is no guarantee that interference will not occur in a particular installation. If this equipment does cause harmful interference to radio or television reception, which can be determined by turning the equipment off and on, the user is encouraged to try to correct the interference by one of more of the following measures:

- Reorient or relocate the receiving antenna.
- Increase the separation between the equipment and receiver.
- Connect the equipment into an outlet on a circuit different from that to which the receiver is connected.
- Consult the dealer or an experienced radio/TV technician for help.

General Datalog Specifications

Storage: 360 hours at 15-second intervals

Memory type: Wraparound memory ensures most recent data is always saved

Sample rate: One reading every 1-120 seconds

Data recorded: All sensor readings, all alarm conditions, calibrations, event flags, battery status, sensor status, confidence/compliance beep activation, IntelliFlash activation, and detector status that includes the time and date for each reading and unit serial number

Operation: Requires no user intervention (automatic)

Compatible with: Desktop PC computer or laptop

Operating system: Windows XP or Window Vista

Download via: IR device (IR Link adapter or MicroDock II base station)

Support:

Fleet Manager II: Reports are generated using the detector datalogs and the Fleet Manager II application. Filters can be defined using Fleet Manager II, or data can be exported to Microsoft Excel for custom reports.

Software requirements:

- Windows XP or Windows Vista
- Fleet Manager II
- Microsoft Excel (optional)

Wear yellow. Work safe.

127908 EN-B

©2017 BW Technologies by Honeywell. All rights reserved.